



**无锡旭晔机械设备有限公司**  
WUXI XUYUE MECHANICAL EQUIPMENT CO.,LTD.

地 址：江苏省宜兴市经济开发区凯旋路19-5号  
邮 编：214203  
电 话：+86-510-87566868 87833711  
传 真：+86-510-87565988  
邮 箱：lxg@xy-me.cn xuyelxg07@126.com  
网 址：www.xy-me.cn

Address: NO.19-5,Kaixuan Road,Yixing Economic  
Development Zone ,Jiangsu Province  
P.C.: 214203  
Tel: +86-510-87566868 87833711  
Fax: +86-510-87565988  
Email: lxg@xy-me.cn xuyelxg07@126.com  
Http: //www.xy-me.cn



微信号: L13506156118

本公司有保留对本产品设计更改权利  
若产品内容有更新恕不另行通知

多功能过滤、洗涤、干燥（三合一）机  
水平叶片（芬特）过滤机  
全自动板式密闭过滤机  
高效板式密闭过滤机  
自清式滤芯过滤机  
卧式叶片过滤机  
A1、A2级压力容器及非标压力容器  
碟片离心机

Multifunction filtered, washed, dried (three in one) machine  
Horizontal blade (Fendt) Filter  
Automatic plate sealed filter  
Efficient plate sealed filter  
Self-Cleaning Filter filter  
Horizontal leaf filter  
A1, A2 grade pressure vessel and non-standard pressure vessel  
Disc Centrifuge



**无锡旭晔机械设备有限公司**  
WUXI XUYUE MECHANICAL EQUIPMENT CO.,LTD.





当您公司的技术团队与生产团队遇到以下问题：

When your company's technical team and production team encounter the following problems:

- ◇ 想对您公司物料生产成本进行控制，对工艺中辅助流体需要回收整合再利用犯难时；
- ◇ 当您的物料品质出现下降,色泽、不溶物去除、不同比重的2种液体无法处理时；
- ◇ 当您的技术团队为您打造一条全新的工艺流程时对设备所需材质，设备选型无从下手时；
- ◇ 也许您使用过与我们同类型的产品却始终未能达到理想效果。
- ◇ You want to control the company's cost of production materials, auxiliary fluid to the process need to be recycled at recycling screenwriters integration;
- ◇ When your material quality decline, color, insolubles removal of two kinds of liquids with different specific gravities can not handle when;
- ◇ When your technical team for you to create a new process when the required material equipment, equipment selection can not start when;
- ◇ Maybe you've used the same type of product with us they did not achieve the desired effect.

请您与我联系：



## 企业简介》》 Company introduction

无锡旭晔机械设备有限公司坐落于国家级环保经济开发区 - 宜兴经济技术开发区。公司致力于过滤机械、分离机械技术发展，求真于各行各业，深入对客户物料解析，贴近客户生产所需制造设备，并结合国内外著名研究院、院校技术突破自身发展瓶颈，公司管理层秉承“工欲善其事，必先利其器”的原则对生产所用设备快速更新与维护，保证公司产品尺寸精准度无偏差。公司营销团队以“负责、务实、真诚”的工作原则服务于各行各业新老客户，期待新老客户莅临我公司洽谈、指导、合作，创造双赢新工作面。

Wuxi Xuye Mechanical Equipment Co., Ltd. is located in the National Environmental Economic Development Economic and Technological Development Zone, the company is committed Yixing mechanical filtration, separation machinery technology development, truth in all walks of life, in-depth analytical materials to customers, production closer to customers principles need manufacturing equipment, combined with famous research institute, college technological breakthroughs own development bottleneck, management companies uphold 'we must first sharpen his tools' used in the production of equipment for rapid updating and maintenance, to ensure the company size accuracy unbiased company marketing team to 'responsible, pragmatic and sincere' working principle of serving the new and old customers all walks of life and look forward to new and old customers to recommend our company to negotiate temporary, guidance, cooperation and create a win-win new Face.

总经理：吕旭钢  
General Manager:Xugang Lv



# 荣誉证书

## Certificates

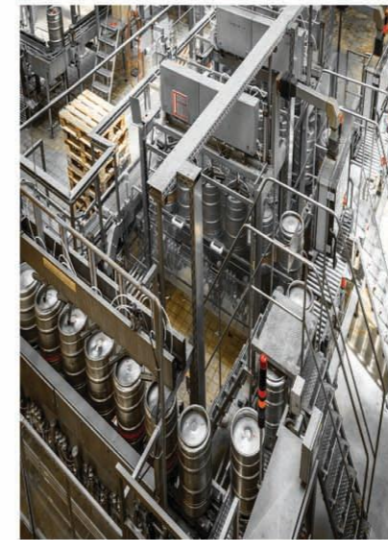

Page 01-03

**XY-EXE系列**  
**多功能过滤、洗涤、干燥(三合一)**  
 设备技术参数  
 设备部件细照  
 工艺流程图

**XY-EXE Series**  
**Multifunction filtered, washed, dried (triple)**  
 Equipment Specifications  
 Fine piece of equipment photos  
 Flow Chart

Page 04-06

**XY-C ( I ) 系列**  
**水平叶片(芬特)过滤机**  
 设备技术参数  
 设备部件细照  
 设备安装框架图

**XY-C ( I ) Series**  
**Horizontal blade (Fendt) filter**  
 Equipment Specifications  
 Fine piece of equipment photos  
 Equipment installation framework map

Page 07-08

**XY-B系列**  
**全自动板式密闭过滤机**  
 设备技术参数  
 设备部件细照

**XY-B Series**  
**Horizontal blade (Fendt) filter**  
 Equipment Specifications  
 Fine piece of equipment photos

# 生产设备及车间一角

## Production equipment and Workshop



# CONTENTS

## 目录

旭晔，流体处理方案、流体工艺效率提升整合者



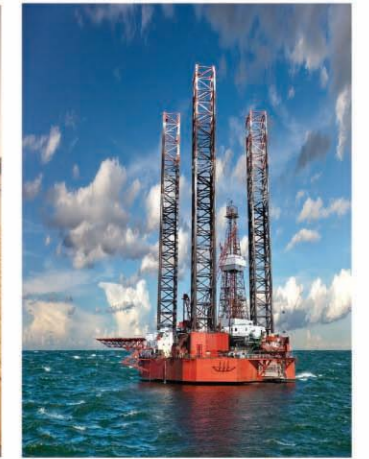
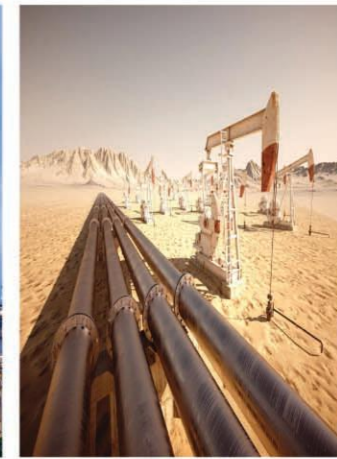

Page 09-11

**XY-A系列**

**高效板式密闭过滤机**

设备技术参数

设备部件细照

设备双联工艺图

**XY-A Series**

**Efficient sealed filter plate**

Equipment Specifications

Fine piece of equipment photos

Equipment duplex artwork

Page 12-13

**XY-AG 系列**

**自清式滤芯过滤机**

设备技术参数

设备部件细照

**XY-AG Series**

**Self-cleaning cartridge filter**

Equipment Specifications

Fine piece of equipment photos

Page 14-16

**XY-D系列**

**袋式(多袋式)过滤机**

设备技术参数

设备部件细照

**XY-D Series**

**Bag (multi-bag) filter**

Equipment Specifications

Fine piece of equipment photos

Page 17-18

**XY-Z系列**

**水平纸板精滤机**

设备技术参数

设备部件细照

**XY-Z Series**

**The level of fine filter cardboard**

Equipment Specifications

Fine piece of equipment photos

Page 19-20

**XY-W系列**

**卧式叶片过滤机**

设备技术参数

设备部件细照

工艺管线图

**XY-W Series**

**Horizontal leaf filter**

Equipment Specifications

Fine piece of equipment photos

Process piping diagram

Page 21-23

**XY-JL 系列**

**滤芯式过滤机**

设备技术参数

设备部件细照

**XY-JL Series**

**Cartridge Filter**

Equipment Specifications

Fine piece of equipment photos

Page 24-25

**XY-N系列**

**A1、A2级压力容器及非标压力容器  
列管冷凝器、螺旋板式  
换热器**

设备技术参数

设备部件细照

**XY-N Series**

**A1, A2 grade pressure vessel and non-standard pressure vessels  
Condenser tube, spiral plate heat exchanger**

Equipment Specifications

Fine piece of equipment photos

Page 26-30

**XY-DH系列**

**碟片离心机  
卧式螺旋卸料沉降离心机**

设备技术参数

设备部件细照

**XY-DH Series**

**Disc centrifuge  
Horizontal Screw Centrifuge**

Equipment Specifications

Fine piece of equipment photos

选择旭晔,我们为您考虑的更多!

选择旭晔,我们为您考虑的更多!





## XY-EXE系列 多功能过滤、洗涤、干燥（三合一）机 XY-EXE Series Multifunction Filtered、Washed And Dried (triple) Machine

XY-EXE系列多功能过滤、洗涤、干燥(三合一)机是一种集过滤、洗涤、干燥、搅拌、反应、结晶、自动出渣于一体的多功能固液分离设备.它广泛应用于染料,精细化工,农药,食品,印染等行业。

XY-EXE series multifunctional filter, washed, dried (triple) machine is a set of filtering, washing, drying, mixing, reaction, crystallization, automatic slag multifunctional solid-liquid separation equipment. It is widely used in dyes, fine chemicals, pesticides, food, printing and dyeing industries.

### 产品特点 Features

1. 完全密闭过滤、无泄漏、无任何污染环境。
2. 在加压或真空状态下操作，实现固液分离；过滤时滤饼分布均匀，固液分离效果好。
3. 液压控制搅拌系统的升降，过滤中最大限度地增加容渣空间，搅拌桨叶的升降和搅拌，使得清洗时滤饼和清洗液充分混合，滤饼得到充分洗涤，干燥时大大减少时间，提高效率。
4. 排渣阀液压控制，排渣系统自动刮渣出料，降低劳动强度。
5. 特别适用于含固量大，液相和固相分别回收适用的过滤场合。
6. 过滤采用水平铺设滤材(可选用金属滤网,滤布,烧结网,T型网)，一次过滤干净彻底，无残液，滤材精度，根据产品要求而选取，滤材密封结构独特，更换滤材方便，快捷。
7. 针对腐蚀性强的材料，设备内部可以衬耐腐蚀里，搅拌轴升降滚筒部分由耐腐蚀性极好的特种合金制作。
8. 过滤前可在机体内进行搅拌、混合、打浆处理，过滤后可在机体内进行清洗，再生处理，干燥等多种工艺操作。具有简化工艺流程同，提高生产效率，防止物料污染，物料更换方便，机电一体化等特点。同时使整个生产过程的厂房面积大幅度减少，降低客户的基础投资费用。



1. Fully enclosed filter, no leakage, no environmental pollution.
2. The pressure or vacuum operation, realize the solid-liquid separation. When the filter cake distribution, good solid-liquid separation effect.
3. The lifting hydraulic control system of mixing, filtering to maximize slag containing space, mixing and stirring movements of the blades, fully mixed filter cake cleaning liquid and makes cleaning, fully washing cake, reduce the time, improve efficiency greatly when dry.
4. Hydraulic control valve slag, slag removal system of automatic scraping slag discharge, reduce the labor intensity.
5. Especially suitable for containing a large quantity of solid, liquid and solid phase were recovery filter suitable situation
6. Laying the level of filtering using filter (can use metal filter, filter cloth, sintered net, T net), a filter completely clean, no residual liquid, precision filter, which is selected according to the requirements of the product, filter sealing structure is unique, the filter material replacement convenient, fast.
7. According to the corrosion resistance of materials, equipment inside can lining corrosion, a stirring shaft lifting cylinder part is composed of a special alloy corrosion resistance excellent production.
8. Filtering can be performed before mixing, in vivo mixing, beating processing, filtering after the regeneration treatment for cleaning, in the body, drying and other processes operating. Has the advantages of simple process flow, improve the production efficiency, prevent pollution and convenient replacement materials, materials, mechanical and electrical integration features. At the same time, so that the whole production process, the workshop area greatly reduce investment costs, reduce customer base.



## XY-EXE系列 多功能过滤、洗涤、干燥（三合一）机 XY-EXE Series Multifunction Filtered、Washed And Dried (triple) Machine

### 设备技术参数

Equipment technical parameters

### 主要规格技术参数

#### The main specifications and technical parameters

型号 Model	过滤面积 The filter area (M <sup>2</sup> )	筒体直径 Diameter of cylinder (mm)	工作压力 Working pressure (Mpa)	公称容积 Nominal volume (M <sup>3</sup> )	滤饼高度 The filter cake height (mm)
XY-EXE-600	0.28	600	-0.1~0.3	0.2	150
XY-EXE-800	0.5	800	-0.1~0.3	0.5	180
XY-EXE-1200	1.1	1200	-0.1~0.3	1.3	250
XY-EXE-1600	2.0	1600	-0.1~0.3	2.8	350
XY-EXE-2000	3.1	2000	-0.1~0.3	4.8	400
XY-EXE-2400	4.5	2400	-0.1~0.3	6.5	450
XY-EXE-2600	5.3	2600	-0.1~0.3	8.7	450
XY-EXE-3200	8	3200	-0.1~0.3	10	500
XY-EXE-3500	9.6	3500	-0.1~0.3	13	600

### 旭晔对材料的使用拥有多变的策略性

#### The use of material Xu Ye have strategic changing

主体材质: 碳钢Q235B | 不锈钢SUS304 | 不锈钢SUS316L | 钛材TA2、TA3 | 哈氏合金 | 英科耐尔Inconel |

内部防腐处理: 内衬特氟龙 | 内衬PP、PE、PO | 内衬玻璃钢

密封圈材质: 丁晴橡胶 | 四氟 | 包四氟 | 氟橡胶

The main material: Carbon steel Q235B Stainless steel SUS304 Or SUS316L Titanium TA2、TA3 Inconel

Internal corrosion treatment: Teflon lined | lined with PP, PE, PO | glass-lined steel

Ring material: NBR | tetrafluoroethylene | bag tetrafluoroethylene | Viton

### 设备工艺流程图

#### Equipment and process flow chart

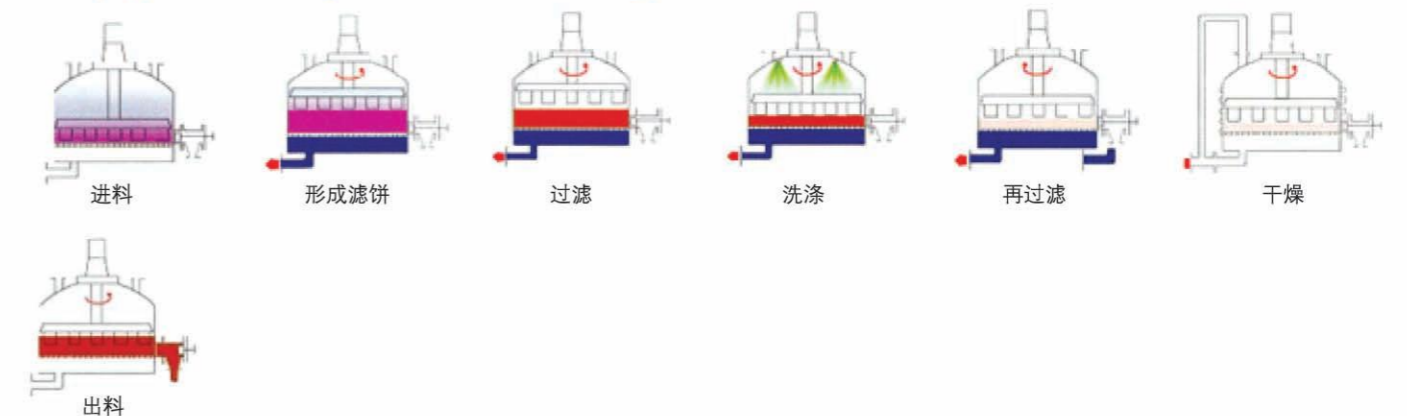





## XY-EXE-系列多功能过滤、洗涤、干燥机 XY-EXE-Series Multifunctional filtering, wash, Drying machine

### 产品简介 Product of products

XY-EXE-系列多功能过滤、洗涤、干燥机是一种集过滤、洗涤、干燥、搅拌、反应、自动出渣于一体的多功能固液分离设备。广泛应用于精细化工，农药，石油，食品，医药等行业。

XY-EXE-Series Multifunctional filtering, wash, Drying machine is a set filter, drying, stirring, reaction, Multi-functional solid liquid separation equipment with automatic slag discharge. Widely used in fine chemicals, pesticide, oil, food, Medical and other industries.

### 产品特点 Product characteristics

- 1、完全密闭过滤，无渗漏，无任何环境污染。
- 2、在加压或真空状态下操作，实现固液分离。过滤时滤饼分部均匀，固液分离效果好。
- 3、升降电机搅拌系统，过滤中最大限度的增大容渣空间，搅拌桨叶的升降和搅拌，使的清洗时滤饼和清液充分混合，滤饼得到充分洗涤，干燥时大大减少时间，提高效率。
- 4、底部全自动形式出料，降低劳动强度，清洗方便。

主体材质：碳钢Q235B，不锈钢SUS304，不锈钢SUS16L.

密封圈材质：丁晴橡胶，四氟，包四氟，氟橡胶

内部防腐处理：内衬特氟龙，内衬PP、PE、PO，内衬玻璃钢。

- 1, Complete closed filtration, no leakage, no environmental pollution.
- 2, operate under pressure or vacuum, achieve solid liquid separation. Filter cake parts are uniform when filtration, solid liquid separation effect is good.
- 3, lift motor stirring system, the maximum increase of slag space in the filtration, stir the lifting and stirring of the blade, so that the filter cake and the cleaning liquid are fully mixed during cleaning, the filter cake is fully washed, and the drying time is greatly reduced. Improve efficiency.
- 4, the bottom of the automatic form of discharge, reduce labor intensity, easy to clean.

Main material: carbon steel Q235B, stainless steel SUS304, stainless steel SUS16L.

Sealed ring material: butyryl rubber, tetrafluorinated, including tetrafluorinated, fluorinated rubber

Internal anti-corrosion treatment: lining Teflon, lining PP, PE, PO, lining glass steel.



## XY-ZHQ-系列组合过滤机 XY-ZHQ-Series combined filters

### 产品简介 Product of products

XY-ZHQ-系列组合过滤机、搅拌、反应一体设备。广泛应用于精细化工，农药，食品，医药，实验室等领域。

XY-ZHQ-series combined filters, stirring and reaction equipment. It is widely used in fine chemical industry, pesticide, food, medicine, laboratory and other fields.

### 产品特点 Product characteristics

该设备由接受罐,过滤器,组合而成。物料可以进一步反应，过滤。实现了结合化生产，方便过滤的灵活性。

The equipment is composed of receiving tank, filter and combination. Material can be further reacted and filtered. It realizes combined production and facilitates the flexibility of filtration.

- 1.化学相容性广、流量大，压差低，使用寿命长。
- 2.可以通过增加自动阀门及控制系统，实现自动化操作，降低人员劳动强度，减少用人成本。
- 3.利用电刷清洗，清除滤网残留。整个冲洗过程系统可正常工作，无需停机。
- 4.自清洗所使用的物料可以全部回用，可以轻化的实现复杂工艺的提取，从而减少投料的损耗。

### 主要规格参数 Main specification parameters

型号 Type	过滤面积(m <sup>2</sup> ) Filter area		工作压力 Working pressure	公称容积(MPa) Nominal volume		外形尺寸 Outline size
	过滤罐 Filter tank	接受罐 Receiving tank		过滤罐 Filter tank	接受罐 Receiving tank	
XY-ZHQ-800	0.3	0.6	0.25	0.05	0.2	850x900x2000
XY-ZHQ-1000	0.5	0.8	0.25	0.1	0.4	1070x1120x2330
XY-ZHQ-1200	0.8	1.2	0.25	0.3	0.7	1290x1330x2730
XY-ZHQ-1400	1.3	1.8	0.25	0.4	1.6	1710x1780x3010

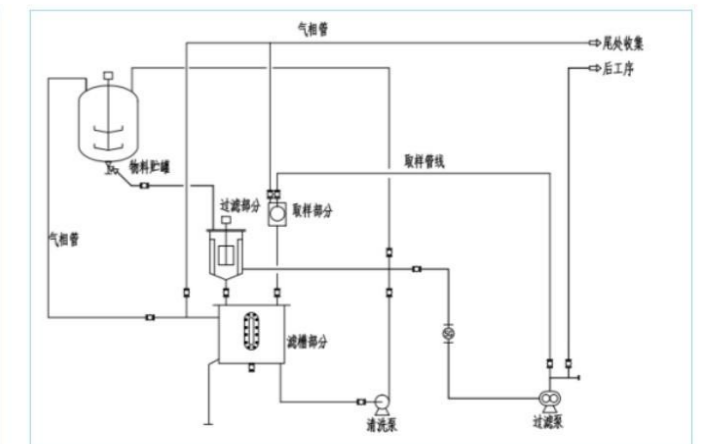
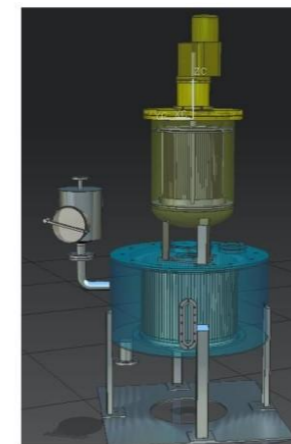

老化树脂聚合物过滤流程





## XY-EXE系列 多功能过滤、洗涤、干燥（三合一）机 XY-EXE Series Multifunction Filtered、Washed And Dried (triple) Machine

设备部件图  
Equipment Parts Figure



## XY-C(I)系列 水平叶片(芬特) 过滤机 XY-C(I) Series Vertical Leaf ( F.T) Filter

水平叶片过滤机具有优良的操作性，可满足过滤系统所要求的不同特性。该机不仅能够全自动无人操作，而且手动操作也轻松自如。它不仅仅只是把含有细微粒子的液体分离为澄液和滤饼，同时还会使包括过滤在内的整个工艺流程变得异常准确与合理。该机在有机化工、石油化工、制药工业等广泛领域里发挥着至关重要的作用。

Level leaves filter with excellent maneuverability, filtration systems to meet the different characteristics required. The machine can not only automatic unattended operation, and manual operation ease. It is not just the liquid containing fine particles separated into liquid and cake Cheng, while also making the entire process including filtering, including becomes extremely accurate and reasonable. The aircraft in the broad areas of organic chemical, petrochemical, pharmaceutical and other industries in plays a crucial role.

### 产品简介 Product Introduction

XY-C(I)系列水平叶片过滤机是一种高效、节能、自动密闭过滤机的精密澄清过滤设备，水平叶片过滤机有CFR型和CFA型两种型号可供选择，CFR型将滤饼以固态形式排出，CFA型将滤饼通过逆洗以淤浆形式排出。两种型号都由叶片（过滤组件）、机壳和驱动装置三部分组成。

XY-C (I) series of horizontal blade filter is precise clarification filtration equipment a high efficient, energy saving, automatic sealed filter, horizontal blade filter with CFR type and CFA type two models available, CFR type the filter cake is discharged in the form of solid state, CFA type filter cakes by inverse washing slurry discharged to form. Two models are composed of a blade (filter assembly), casing and a driving device is composed of three parts.

### 产品特点 Features

- 1、完全密闭过滤、无泄漏、无任何环境污染。
- 2、滤盘水平设计，滤饼形成稳定，过滤效果好。
- 3、离心排渣，卸渣干净迅速，适应多种粘稠物料的过滤和卸渣。
- 4、滤网清洗容易，不用拆卸，可在机体内进行。
- 5、PLC全自动控制，排渣口可自动打开，设备所有动作均可与DCS控制对接。

- 1.Fully enclosed filter, no leakage, no pollution of the environment.
- 2.The filter disc level design, the cake formation and stability,good filtering effect.
- 3.Centrifugal slag, slag unloading clean quickly, to adapt to a variety of viscous materials and discharging slag filtration.
- 4.Filter cleaning easy, without disassembly, can be in the body.
5. PLC automatic control, slag outlet can be automatically opened,All equipment with DCS control action can be docking.







## XY-C(I)系列 水平叶片(芬特) 过滤机 XY-C(I) Series Vertical Leaf ( F.T) Filter

设备技术参数  
Equipment technical parameters

### 主要规格技术参数

#### The main specifications and technical parameters

型号 Model	过滤面积 The filter area (M <sup>2</sup> )	叶片直径 Blade diameter (mm)	工作压力 Working pressure (Mpa)	公称容积 Nominal volume (M <sup>3</sup> )	外形尺寸 The shape size (mm)
XY-CFR/CFA-2	2	400	0.4	0.35	800 × 3480
XY-CFR/CFA-3	3	600	0.4	0.4	1000 × 3650
XY-CFR/CFA-5	3	600	0.4	0.45	1000 × 4050
XY-CFR/CFA-7	7	800	0.4	0.75	1200 × 3900
XY-CFR/CFA-10	10	800	0.4	1.2	1200 × 4250
XY-CFR/CFA-15	15	1000	0.4	1.5	1600 × 4400
XY-CFR/CFA-20	20	1000	0.4	2.5	1600 × 4950
XY-CFR/CFA-25	25	1000	0.4	2.8	1600 × 5480
XY-CFR/CFA-30	30	1000	0.4	3	1600 × 6100
XY-CFR/CFA-35	35	1000	0.4 </td <td>3.2</td> <td>1600 × 7112</td>	3.2	1600 × 7112

### 旭晔对材料的使用拥有多变的策略性

#### The use of material Xu Ye have strategic changing

主体材质: 碳钢Q235B | 不锈钢SUS304 | 不锈钢SUS316L | 钛材TA2、TA3 | 哈氏合金 | 英科耐尔Inconel |

密封圈材质: 丁晴橡胶 | 四氟 | 包四氟 | 氟橡胶

滤网材质: 不锈钢SUS304 | 不锈钢SUS316L

The main material: Carbon steel Q235B | Stainless steel SUS304 Or SUS316L | Titanium TA2、TA3 | Inconel |

Ring material: NBR | tetrafluoroethylene | bag tetrafluoroethylene | Viton

Filter Material: Stainless steel SUS304 | stainless steel SUS316L



过滤整机单元  
Filtration machine unit



过滤机主轴及滤盘  
Filter and filter disc spindle



## XY-C(I)系列 水平叶片(芬特) 过滤机 XY-C(I) Series Vertical Leaf ( F.T) Filter

设备安装框架图  
Equipment installation framework map

### 设备安装框架图

#### Equipment installation framework map

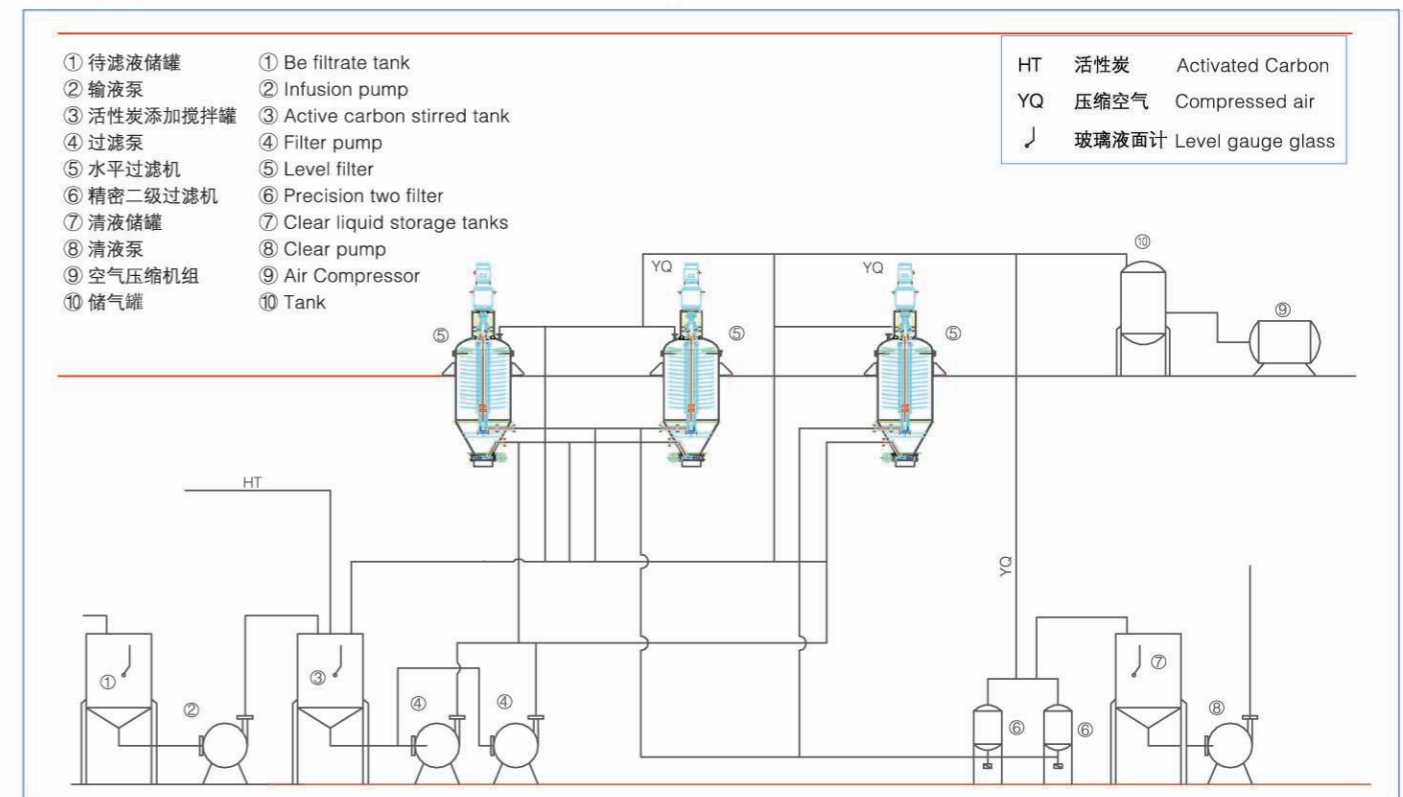

底部阀门结构可选:  
The bottom valve structure is optional:





## XY-B系列 全自动板式密闭过滤机 XY-B Series Automatic Plate Sealed Filter



XY-B系列全自动板式密闭过滤机是一种高效率、节能、全自动密闭工作的澄清过滤设备。它广泛应用于化工、食品、石油、制药等行业。

XY-B series automatic plate sealed filter is clarified a high efficiency filter, energy saving, full automatic closed work. It is widely used in petroleum, chemical, food, pharmaceutical and other industries.

### 产品特点 Features

- 1、全密闭过滤、无泄漏、无任何环境污染。
- 2、一次过滤澄清，精度可达PPM级。
- 3、过滤不用滤纸、滤布、过滤成本低。
- 4、可完全回收滤液、无残液。
- 5、PLC全自动控制，排渣口可自动打开，设备所有动作均可与DCS控制对接。

- 1.Full sealed filter, no leakage, no pollution of the environment.
- 2.A clarification, precision can reach PPM.
- 3.The filter without filter paper, filter cloth, filter and low cost.
- 4.The filtrate can be completely recycled, no residual liquid.
5. PLC automatic control, slag outlet can be automatically opened, All equipment with DCS control action can be docking.



滤网在设备内部细照  
Fine strainer inside the device according to the



滤网正面  
Filter positive



底部余料过滤网  
I expected the bottom of the filter



底部快开结构部件照  
The bottom of the quick opening structural components according to

## XY-B系列 全自动板式密闭过滤机 XY-B Series Automatic Plate Sealed Filter



### 设备技术参数 Equipment technical parameters

### 主要规格技术参数

#### The main specifications and technical parameters

型号 Model	过滤面积 The filter area (M <sup>2</sup> )	处理能力(T/H) Processing capacity			工作压力 Working pressure (Mpa)	公称容积 Nominal volume (M <sup>3</sup> )	外形尺寸 The shape size (mm)
		食品 Food	石化 Petrochemistry	油脂 Oil			
XY-B-2	2	2~3	2~5	1~1.2	0.4	0.2	1500 × 1300 × 1950
XY-B-5	5	4~6	5~7	1.4~2	0.4	0.3	1600 × 1400 × 2000
XY-B-10	10	6~8	7~9	2~3	0.4	0.8	1700 × 1500 × 2320
XY-B-15	15	9~12	11~13	3~5	0.4	1.3	2050 × 2100 × 1900
XY-B-20	20	12~16	15~17	5~7	0.4	1.6	2050 × 2100 × 2200
XY-B-25	25	15~20	19~21	7~9	0.4	1.9	2050 × 2100 × 2600
XY-B-30	30	18~24	23~25	9~11	0.4	2.3	2600 × 2500 × 3600

### 旭晔对材料的使用拥有多变的策略性

#### The use of material Xu Ye have strategic changing

主体材质: 碳钢Q235B | 不锈钢SUS304 | 不锈钢SUS316L | 钛材TA2、TA3 | 哈氏合金 | 英科耐尔Inconel |

密封圈材质: 丁晴橡胶 | 四氟 | 包四氟 | 氟橡胶

滤网材质: 不锈钢SUS304 | 不锈钢SUS316L

The main material: Carbon steel Q235B | Stainless steel SUS304 Or SUS316L | Titanium TA2、TA3 | Inconel |

Ring material: NBR | tetrafluoroethylene | bag tetrafluoroethylene | Viton

Filter Material: Stainless steel SUS304 | stainless steel SUS316L

### 筒体表面处理

#### Cylinder surface treatment



不锈钢拉丝处理  
Brushed stainless steel



筒体半盘管  
Semi-cylinder coil



GMP镜面抛光  
GMP mirror polished





## XY-A系列 高效密闭板式过滤机 XY-A Series Efficient Sealed Plate Filter

XY-A系列板式密闭过滤机是一种高效、节能、密闭操作的精密澄清过滤设备，使用于色拉油、毛油、石油、树脂、食品、制药、聚醚、环保水处理等行业。

XY-A series plate sealed filter is a kind of high efficiency, energy saving, closed operation precise clarification filtration equipment, used in salad oil, crude oil, oil, resin, food, pharmaceutical, polyether, environmental water treatment and other industries.

### 产品特点 Features

该产品设计结构独特，体积小，过滤效率高，滤液透明度和细度好，无物料消耗，不消耗滤纸，滤布或纸芯，而只消耗少量的助滤剂，因而过滤成本很低，设备操作、维护、清理方便。

It is remarkable for its novel structure, small volume, high filtering efficiency, good transparency and fineness of the filtering fluid, no using of filter paper or cloth and less consumption of materials; so its cost very low, and it is easy to be operated and maintained.

### 产品用途及适用范围 Purpose and Scope

油脂行业：机榨毛油过滤，脱色油过滤，氢化油过滤、冬化油过滤等。

食品行业：砂糖、葡萄糖等糖液的活性炭脱色过滤，酒类、果汁、清凉饮料等的澄清过滤。

化学行业：石化工业，无机化工，有机化工各过程中的结晶体分离，各种催化剂的过滤分离，化工产品脱色过滤等。

环保行业：江、河、湖泊取水用，污水处理站上清液保险提纯过滤，游泳池回用水提纯过滤。

Oil industry: hair-pressing machine oil filter, oil filter decolorization, hydrogenated oil filters, oil filters, such as winter.

Food industry: sugar, glucose, such as the sugar solution activated carbon filter decolorization, wine, fruit juice, soft drinks and so on to clarify the filter.

Chemical industry: petrochemical industry, inorganic chemicals, organic chemicals in the process of the crystals separated from the catalyst for a variety of filtering separation, chemical products, such as decolorization filter.

Environmental protection industry: rivers, lakes, water, sewage treatment station supernatant insurance purification filters, water purification filter back to the swimming pool.



滤网  
Filter

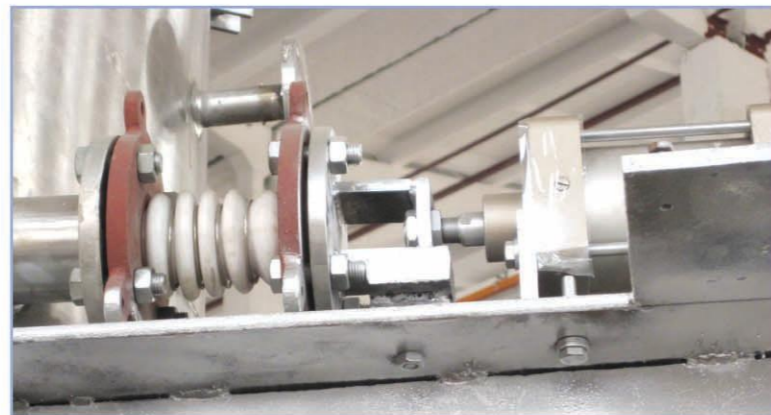

振动排渣机构  
Vibration slugging agency



## XY-A系列 高效密闭板式过滤机 XY-A Series Efficient Sealed Plate Filter

### 设备技术参数 Equipment technical parameters

### 主要规格技术参数

#### The main specifications and technical parameters

型号 Model	过滤面积 The filter area (M <sup>2</sup> )	滤饼体积 Cake volume (L)	处理能力(T/H) Processing capacity			工作压力 Working pressure (Mpa)		工作温度 Working temperature (°C)	过滤缸容积 Filtration tank volume (L)	主机重量 Weight (kg)
			油脂 Oil	树脂 Resin	饮料 Beverages	额定压力 Rated pressure	最高压力 Maximum pressure			
XY-A-2	2	30	0.4~0.6	1~1.5	1~3	0.1~0.4	0.5	≤150	120	300
XY-A-4	4	60	0.5~1.2	2~3	2~5	0.1~0.4	0.5	≤150	250	400
XY-A-7	7	105	0.5~1.8	3~6	4~7	0.1~0.4	0.5	≤150	420	600
XY-A-10	10	150	1.0~3	5~8	6~9	0.1~0.4	0.5	≤150	800	900
XY-A-12	12	240	1~4	6~9	8~11	0.1~0.4	0.5	≤150	1000	1100
XY-A-15	15	300	1.5~5	7~12	10~13	0.1~0.4	0.5	≤150	1300	1300
XY-A-20	20	400	2.5~6	9~15	12~17	0.1~0.4	0.5	≤150	1680	1700
XY-A-25	25	500	3~7	12~19	16~21	0.1~0.4	0.5	≤150	1900	2000
XY-A-30	30	600	4~8	14~23	19~25	0.1~0.4	0.5	≤150	2300	2500
XY-A-36	36	720	4.5~9	16~27	23~31	0.1~0.4	0.5	≤150	2650	3000
XY-A-45	45	900	5.5~11	21~34	30~38	0.1~0.4	0.5	≤150	3200	3500
XY-A-52	52	1040	6.5~13	24~39	36~44	0.1~0.4	0.5	≤150	3800	4000
XY-A-60	60	1200	7.5~15	27~45	42~51	0.1~0.4	0.5	≤150	4500	4500
XY-A-70	70	1400	8.5~15	30~52	48~60	0.1~0.4	0.5	≤150	5800	5500
XY-A-80	80	1600	9.5~18	36~60	56~68	0.1~0.4	0.5	≤150	5860	6000
XY-A-90	90	1800	10.5~21	40~68	64~78	0.1~0.4	0.5	≤150	6700	6500

### 旭晔对材料的使用拥有多变的策略性

#### The use of material Xu Ye have strategic changing

主体材质：碳钢Q235B | 不锈钢SUS304 | 不锈钢SUS316L | 钛材TA2、TA3 | 哈氏合金 | 英科耐尔Inconel |

密封圈材质：丁晴橡胶 | 四氟 | 包四氟 | 氟橡胶

滤网材质：不锈钢SUS304 | 不锈钢SUS316L

The main material: Carbon steel Q235B | Stainless steel SUS304 Or SUS316L | Titanium TA2, TA3 | Inconel |

Ring material: NBR | tetrafluoroethylene | bag tetrafluoroethylene | Viton

Filter Material: Stainless steel SUS304 | stainless steel SUS316L





## XY-A系列 高效密闭板式过滤机 XY-A Series Efficient Sealed Plate Filter

设备双联工艺图  
Equipment duplex artwork

### ■ 设备双联工艺图 Equipment duplex artwork

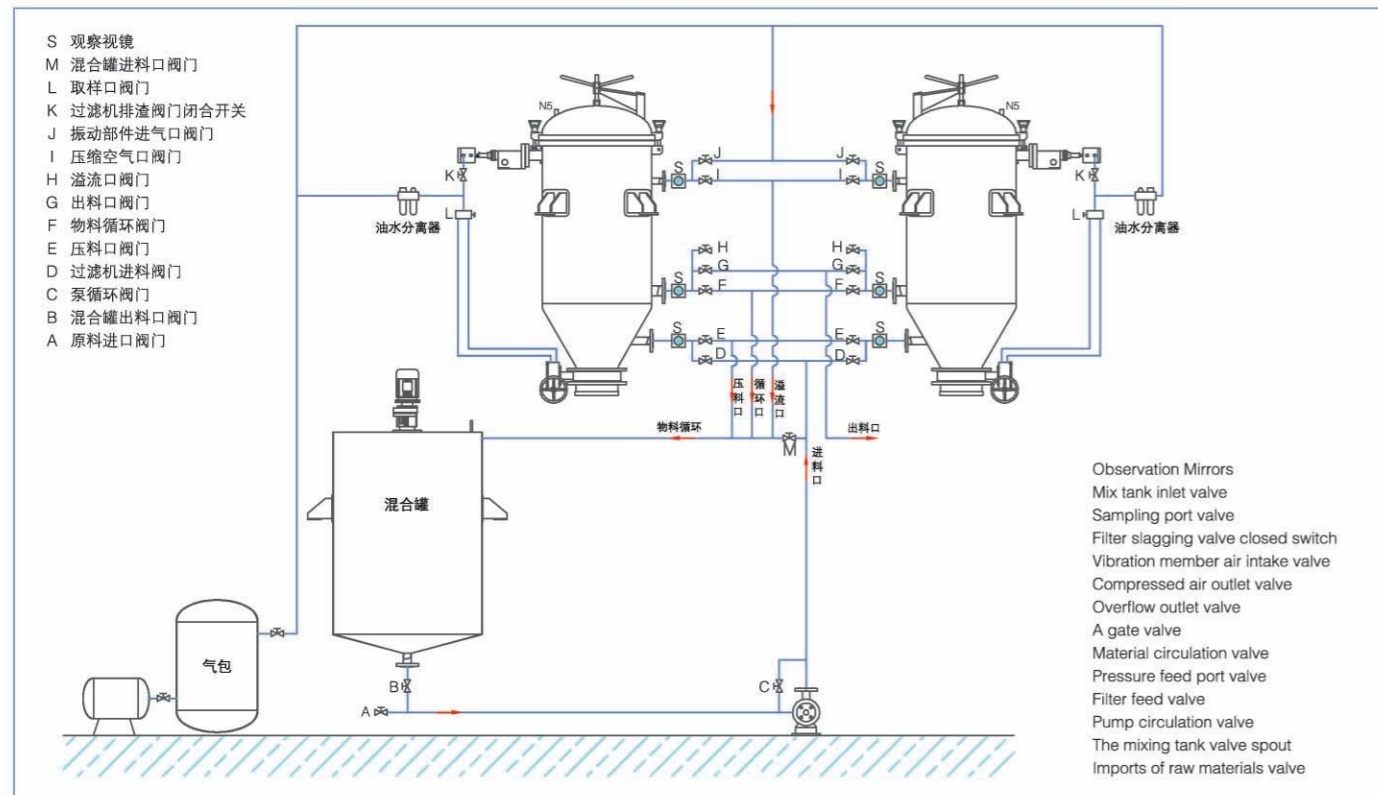

底部阀门结构可选:  
The bottom valve structure is optional:

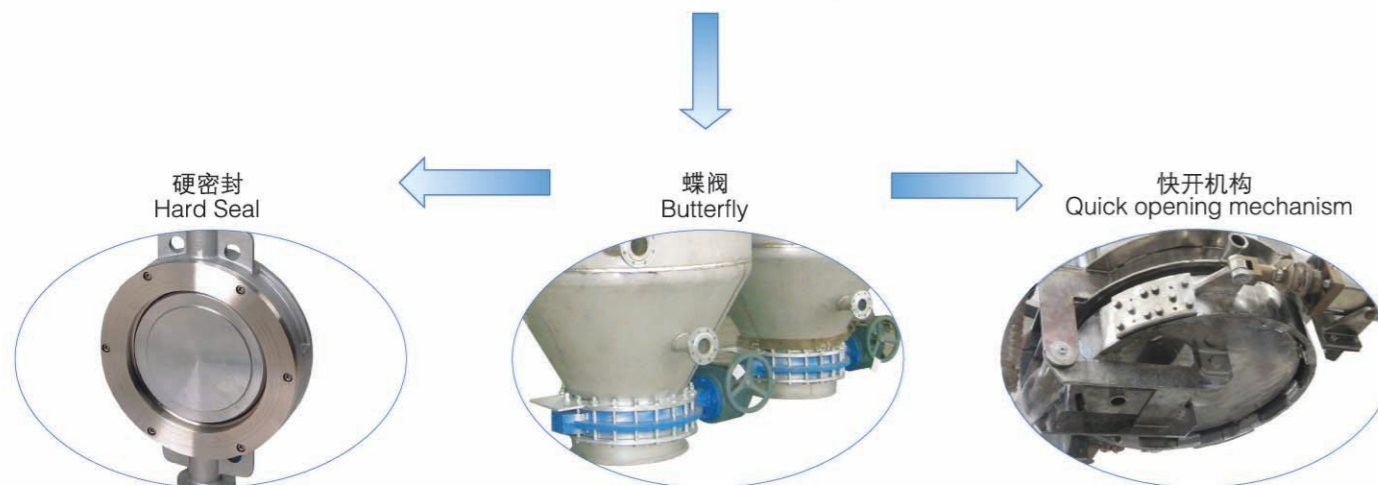

## XY-AG系列 自清式滤芯过滤机 XY-AG Series Of Self-cleaning Cartridge Filter

XY-AG系列自清式滤芯过滤机是一种高效、节能、自动密闭过滤的精密澄清设备。  
XY-AG series self-cleaning filter is a kind of clarifying separation equipment with high-efficiency, energy-saving and enclosed operation.

### ■ 产品特点 Features

- 1、完全密闭过滤，无泄漏，无任何环境污染。
- 2、滤芯设计采用复式结构，应用领域广，过滤效果好。
- 3、能实现一次性完全过滤。
- 4、滤饼可进行洗涤、干燥，以获得最大的经济效益。
- 5、采用气体反吹排渣，排渣干净迅速，适应多种粘稠物料。

- 1、Completely enclosed filtration, no leakage, no pollution.
- 2、The filtering core adopts component structure which can be used widely and excellent filtering effect.
- 3、It can be thoroughly filtered once.
- 4、Filter cake can be washed and dried in that it can achieve the best economical benefit.
- 5、Adopting air blowing in reverse to discharge the residue which is rapid and clean, and also used in various sticky materials.

### ■ 适用范围 Scope

精细化工、塑料、燃料、电镀、油脂、润滑油、陶瓷、氯碱工业、制药等行业的过滤、吸附和贵金属催化剂、沸石等固体的回收。

The filtration, adsorption and solid recovery of metal catalyzer, zeolite etc, in the industries of the chemical, plastic, fuel, electricity, grease, lubricant, porcelain, glass, alkali etc.



筒体内部  
Cylinder internal



折叠滤纸滤芯  
Folded filter paper



PP滤芯  
PP filter





## XY-AG系列 自清式滤芯过滤机 XY-AG Series Of Self-cleaning Cartridge Filter

设备技术参数  
Equipment technical parameters

### 主要规格技术参数

#### The main specifications and technical parameters

面积系列 (m <sup>2</sup> )	筒体直径系列 (mm)	工作压力 (Mpa)	工作温度 (°C)	公称过滤精度 (μm)
2~60	Φ300、Φ400 Φ500、Φ600 Φ800、Φ1000 Φ1200、Φ1600	0.4	120 工作温度与使用滤材质有关	1、5、10 15、25、40 50、60、80、 .....

注：根据客户要求，可定制任意多个滤芯和不同长度规格滤芯的滤筒。

According to the users' asking, the filter tank can be made with several filtering cores and different length standard filtering cores.

### 旭晔对材料的使用拥有多变的策略性

#### The use of material Xu Ye have strategic changing

主体材质：碳钢Q235B | 不锈钢SUS304 | 不锈钢SUS316L | 钛材TA2、TA3 | 哈氏合金 | 英科耐尔Inconel |

密封圈材质：丁晴橡胶 | 四氟 | 包四氟 | 氟橡胶

The main material: Carbon steel Q235B | Stainless steel SUS304 Or SUS316L | Titanium TA2、TA3 | Inconel |

Ring material: NBR | tetrafluoroethylene | bag tetrafluoroethylene | Viton



不锈钢折叠滤芯 Stainless steel folded filter  
 不锈钢粉末烧结滤芯 Stainless steel powder sintered filter  
 不锈钢滤芯 Stainless steel filter  
 梯形烧结滤芯 Keystone sintered filter  
 烛式不锈钢滤芯 Stainless steel filter candle



## XY-D系列 袋式(多袋式)过滤机 XY-D Series Bag (multi-bag) Filter

滤袋是过滤机中的重要部分，它决定了过滤的精度。滤袋材质多样，能针对各个应用领域，满足不同的过滤要求。

Filter bag is the main part of the filter which determines the filtering precision. Filter bag can be made by various materials so that it can be used in different fields and meet different filtering requirements.

### 产品简介

#### Product Introduction

袋式过滤机是一种多元化的小型过滤单元，它既可以作为单独的过滤系统，也可以在工艺中肩负二次过滤的重责，它体积小，精度高，滤袋材质多元化，消耗低等特点让它能更轻松的针对各个应用领域。

聚酯无纺布滤袋：耐碱、耐溶剂、耐温90°C，过滤精度为1 μm-600 μm。

尼龙滤袋：耐酸碱、耐溶剂、耐温150°C，单、多纤维编织网，过滤精度为5 μm-1200 μm。

不锈钢过滤网：在加强网内不锈钢丝网，耐高温和高压，可反复清洗，经久耐用，材质有SS304和SS316、SS316L，过滤精度为25 μm-1200 μm。



Bag filter is a filter unit diversified small, it can be used as a separate filtration system, also can be in the process of the two filtering shoulder heavy responsibility, it has the advantages of small size, high precision, bag material diversification, low consumption and make it easier for various applications.

Polyester un-spin filter bag: alkali-resisting, solvent-resisting, heat-resisting 90°C and filter precision is 1 μm-600 μm.

Nylon filter bag: acid-resisting and alkali-resisting, solvent-resisting, heat-resisting 150°C, single or multi fiber weaving net and the filter precision is 5 μm-1200 μm.

Stainless steel filter net: adding the stainless steel net in the reinforcing net can resist high temperature and pressure, repeat washed and prolong service life, The materials are from SS304 and SS316. The filter precision is 25 μm-1200 μm.



不锈钢滤筒 Stainless steel cartridge  
 滤筒内部 Internal cartridge  
 滤袋 Bag



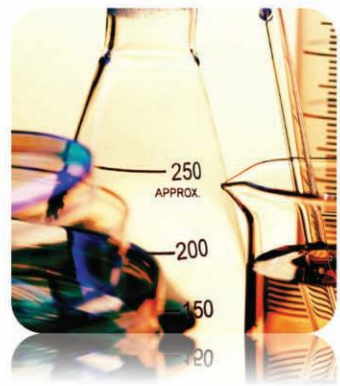

## XY-D系列 过滤整机单元系统 XY-D Series Filtration System Whole Unit

此过滤整机单元应用于实验室，车间应急过滤，量小精度高等小型场合使用。  
This filter machine unit used in laboratories, workshops emergency filtration, a small amount of high precision and small occasions.

### 主要规格技术参数

#### The main specifications and technical parameters

型号 Model	过滤面积 The filter area (m <sup>2</sup> )	进出口径 Export Path (mm)	最高流速 Maximum flow rate m <sup>3</sup> /h <粘度=1厘泊> <Viscosity=1cps>	最高工作压力 Maximum working pressure (Mpa)	最高工作温度 The maximum operating temperature (°C)	公称过滤精度 Nominal filtration accuracy (μm)
XY-D-1pls	0.25	Φ 40	18	0.6	120~350 工作温度与使用滤材有关 120 to 350 Operating temperature with the use of filter material related	1、5、10、15、25、40、50、65、75、80、100、……1200
XY-D-1p2s	0.5	Φ 40	36			

### 旭晔对材料的使用拥有多变的策略性

#### The use of material Xu Ye have strategic changing

主体材质：碳钢Q235B | 不锈钢SUS304 | 不锈钢SUS316L | 钛材TA2、TA3 | 哈氏合金 | 英科耐尔Inconel |

密封圈材质：丁晴橡胶 | 四氟 | 包四氟 | 氟橡胶

滤网材质：不锈钢SUS304 | 不锈钢SUS316L

The main material: Carbon steel Q235B | Stainless steel SUS304 Or SUS316L | Titanium TA2、TA3 | Inconel |

Ring material: NBR | tetrafluoroethylene | bag tetrafluoroethylene | Viton

Filter Material: Stainless steel SUS304 | stainless steel SUS316L



## XY-D系列 袋式(多袋式)过滤机 XY-D Series Bag (multi-bag) Filter

设备技术参数  
Equipment technical parameters

### 型号说明

#### Model Description

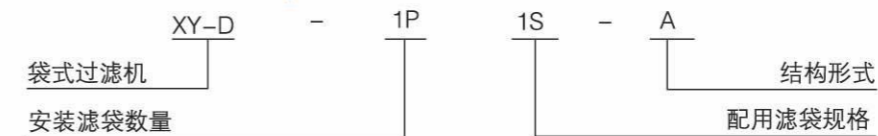

XY-D-1S: 用于标准长度滤纸，过滤面积0.25m<sup>2</sup>。

XY-D-2S: 用于双倍标准长度滤袋，过滤面积0.5m<sup>2</sup>。

XY-D-A: 单过滤机。

XY-D-B: 单过滤机配置泵及管路输送系统，组装在移动式推车上。

XY-D-2B: 双联过滤机配置泵及管路输送系统，可交替，组装在移动式推车上。



多袋过滤机滤筒内部  
Multi-bag filter cartridge inside



内衬喷四氟喷层  
Spray shotcrete lining tetrafluoroethylene



### 主要规格技术参数

#### The main specifications and technical parameters

型号 Model	过滤面积 The filter area (m <sup>2</sup> )	进出口径 Export Path (mm)	最高流速 Maximum flow rate m <sup>3</sup> /h <粘度=1厘泊> <Viscosity=1cps>	最高工作压力 Maximum working pressure (Mpa)	最高工作温度 The maximum operating temperature (°C)	公称过滤精度 Nominal filtration accuracy (μm)
XY-D-4pls	1	Φ80	70	0.6	120~350 工作温度与使用滤材有关 120 to 350 Operating temperature with the use of filter material related	1、5、10、15、25、40、50、65、75、80、100、……1200
XY-D-4p2s	2	Φ80	140			
XY-D-6p2s	3	Φ80	210			
XY-D-8p2s	4	Φ100	280			
XY-D-10p2s	5	Φ100	350			
XY-D-12p2s	6	Φ125	420			
XY-D-16p2s	8	Φ150	560			
XY-D-20p2s	10	Φ200	700			
XY-D-24p2s	12	Φ200	840			





## XY-Z系列 水平纸板精滤机 XY-Z Series Horizontal Paper Filter

XY-Z系列纸板精滤机是一种高效、节能、精密清渣过滤、密闭操作的固液分离设备。它广泛应用于化工、石油、食品、油脂、制药等行业。

XY-Z series paperboard fine filters are high efficiency energy-saving precision filtering closed operation solid-liquid separation equipment. They are extensively applied in chemical, petroleum, oil, pharmaceutical, and other industries.

### 产品特点 Features

该过滤机是在密闭的筒体内，由若干片水平放置的滤板中间装夹滤纸组成。它是依靠滤纸作过滤介质，在密闭容器内进行加压过滤。过滤时，滤液由输送泵送入过滤机体内，沿着滤板外圈周上的小孔进入两层滤板间，滤液穿过滤纸和多孔支撑板，流入滤板中心孔道，从机体底部出料口流出，过滤精度较高。过滤完后，用压缩空气将过滤机内残液压出。

The filter is of closed barrel with several horizontal filtering plates which sandwich filtering papers. It uses filtering paper as the filtering medium and filters by pressure within the closed barrel. When in operation, liquid is pumped into the barrel then it flows to the filtering plates through small holes around the outer side of the filtering plate, then the liquid penetrates the filtering papers and the perforated supporting plate and enters into the center channel of the filtering plate the discharges form bottom of the machine, fine filtering effect is achieved. When the filtering process is finished, residuals in the filter are ejected by compressed air.



### 适用范围 Scope

饮料：啤酒、果汁、酒类、牛奶等

食品：油脂、脱蜡、脱色、脱脂、醋、糖汁、甜水等

医药：双氧水、维生素等

其他：空气、水的净化等

Beverage: Beer, Juice, wine category, Milk Etc.

Foodstuff: Grease, Take off the la, Take off the color, Degrease, Vinegar, Sugae juice, Sweet water Etc.

Curative: An oxygen water, Vitamin Etc.

Other: Air, Water Of Decontamination Etc.



## XY-Z系列 水平纸板精滤机 XY-Z Series Horizontal Paper Filter

### 设备技术参数 Equipment technical parameters

### 主要规格技术参数

#### The main specifications and technical parameters

型号 Model	筒体直径 Cylinder diameter Φ	工作压力 Working pressure ( Mpa )	工作温度 Working temperature ( ° C )	过滤面积 The filter area (m <sup>2</sup> )	进出口径 Export Path ( mm )	处理量 Handling capacity ( m <sup>3</sup> /h )	外形尺寸 Dimensions ( mm )
XY-Z-1.5	400	≤0.3	≤150	1.5	Dg40	2	670 × 975
XY-Z-3	600			3	Dg40	4	970 × 1285
XY-Z-5	800			5	Dg40	7	1100 × 1800
XY-Z-7	800			7	Dg50	10	1100 × 1935
XY-Z-10	900			10	Dg65	13	1300 × 2000
XY-Z-12	900			12	Dg65	15	1300 × 2160

### 旭晔对材料的使用拥有多变的策略性

#### The use of material Xu Ye have strategic changing

主体材质：碳钢Q235B | 不锈钢SUS304 | 不锈钢SUS316L | 钛材TA2、TA3 | 哈氏合金 | 英科耐尔Inconel |

密封圈材质：丁晴橡胶 | 四氟 | 包四氟 | 氟橡胶

滤网材质：不锈钢SUS304 | 不锈钢SUS316L

The main material: Carbon steel Q235B | Stainless steel SUS304 Or SUS316L | Titanium TA2、TA3 | Inconel |

Ring material: NBR | tetrafluoroethylene | bag tetrafluoroethylene | Viton

Filter Material: Stainless steel SUS304 | stainless steel SUS316L



滤盘  
Filter plate



滤盘  
Filter plate





## XY-W系列 卧式叶片过滤机 XY-W Series Horizontal Leaf Filter

XY-W系列卧式叶片过滤机是一种高效、节能、自动密闭过滤的精密澄清设备。广泛应用于化工、石油、食品、制药等行业。

XY-W series horizontal leaf filter is a fine clarify filtrate equipment with high-efficiency, energy-saving and autohermetic. It is widely used in chemicals, petroleum, foodstuff and pharmacy.

### 产品特点 Features

- 1、完全密闭过滤、无泄漏、无任何环境污染。
- 2、滤网板自动拉出结构，便于观察和清渣。
- 3、双面过滤，过滤面积大，容渣量大。
- 4、振动排渣，降低劳动强度。
- 5、液压控制，实现操作自动化。
- 6、该设备可制成大容量、大面积的过滤系统。

- 1、Full hermetic filter, no leakage, no pollution.
- 2、Filtering gauze flakes can be pulled out automatically, and easy to be inspected and cleaned.
- 3、As the leaves filtering on both sides, large filtration area and solids holding capacity can be obtained.
- 4、Automatically residue discharging by which labor can be largely reduced.
- 5、Controlled by hydraulic thus automation is to be.
- 6、A large filtration area large solids holding capacity can be obtained.

### 适用范围 Scope

- 1、干滤饼、半干滤饼及澄清滤液的回收。
  - 2、化工：硫磺、硫酸铝、复合铝化合物、塑料、染料中间体、漂白液、润滑油添加剂、聚乙烯。
  - 3、食品工业：糖汁、油脂、脱蜡、脱色、脱脂。
- 1、Dry, semidry cake and clean filtrate recovery.
- 2、Chemical industries: Sulphur, Aluminum sulfate, Polyaluminum choride, Plastic, dyestuff intermediate, bleaching liquid, lubricant Additives and intermediate and high pressure polyethylene, etc.
- 3、Food industries: Syrups, edible oils, dewaxing, decolour, Degrease.

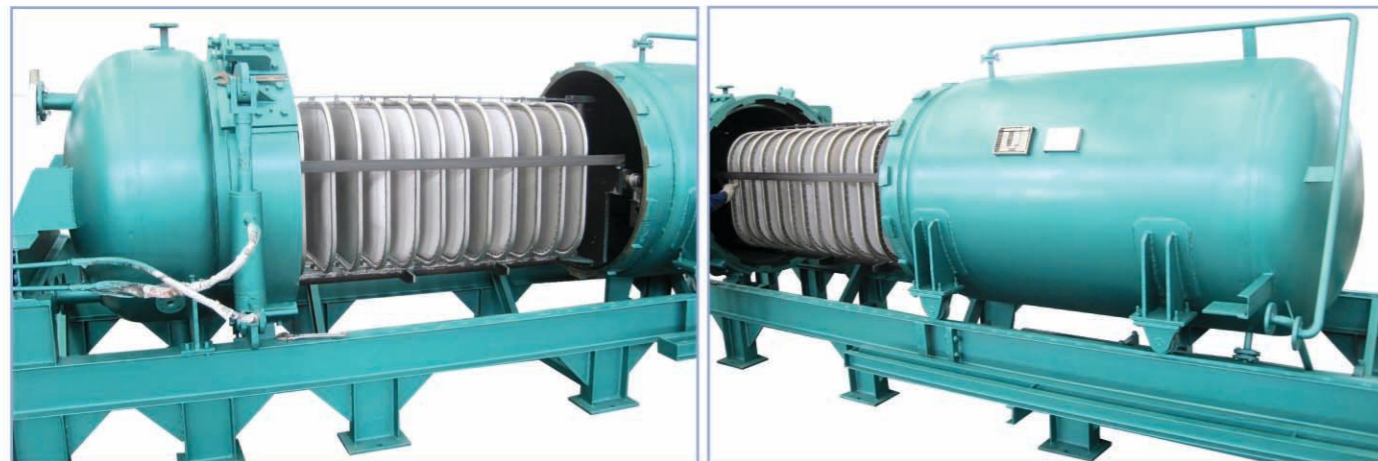

卧式过滤机细节照  
Horizontal filter detail photo



## XY-W系列 卧式叶片过滤机 XY-W Series Horizontal Leaf Filter

### 设备技术参数 Equipment technical parameters

### 主要规格技术参数

#### The main specifications and technical parameters

面积系列 Area Series (m <sup>2</sup> )	筒体直径系列 Cylinder diameter series (mm)	工作压力 Working pressure (Mpa)	工作温度 Working temperature (°C)	处理能力约 Processing capacity of about (T/h·m <sup>2</sup> )	
5, 10, 15, 20, 25, 30, 35, 40, 45, 50, 60, 70, 80, 90, 100, 120, 140, 160, 180, 200	900, 1200, 1400, 1500 1600, 1700, 1800, 2000	0.4	150	油脂	0.2
				饮料	0.8

### 旭晔对材料的使用拥有多变的策略性

#### The use of material Xu Ye have strategic changing

主体材质：碳钢Q235B | 不锈钢SUS304 | 不锈钢SUS316L | 钛材TA2、TA3 | 哈氏合金 | 英科耐尔Inconel |

密封圈材质：丁晴橡胶 | 四氟 | 包四氟 | 氟橡胶

滤网材质：不锈钢SUS304 | 不锈钢SUS316L

The main material: Carbon steel Q235B Stainless steel SUS304 Or SUS316L Titanium TA2、TA3 Inconel

Ring material: NBR | tetrafluoroethylene | bag tetrafluoroethylene | Viton

Filter Material: Stainless steel SUS304 | stainless steel SUS316L

### 工艺管线图

#### Process piping diagram

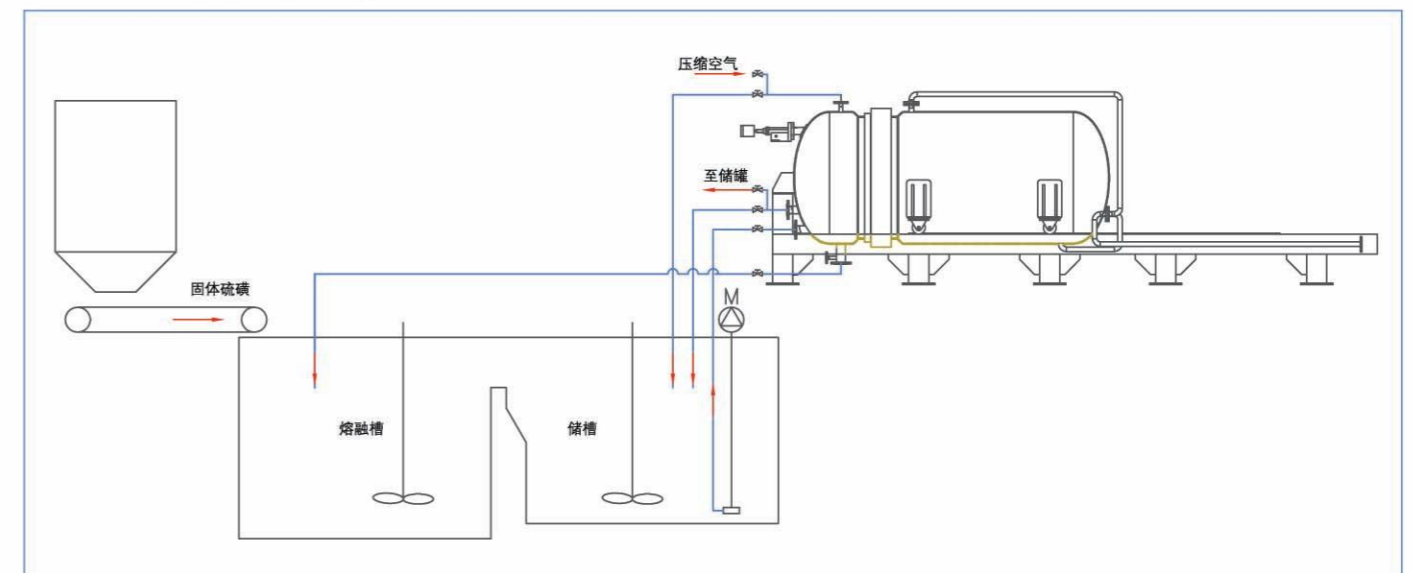





## XY-JL系列 滤芯式过滤机 XY-JL Series Filtering Core Filter

XY-JL系列滤芯过滤机是一种高效、节能、密闭操作、精密澄清的固液分离设备。设计结构独特、体积小、装卸滤芯十分方便，滤筒清洗方便简单。该过滤机是在密闭筒体内，有若干支滤芯垂直装在滤板上组成，滤芯作为过滤介质，在密闭的筒体内进行加压过。

XY-JL series filter element is a high-performance, energy-saving, closed operations, to clarify the precision of the solid-liquid separation equipment. The unique design of the structure, small size, filter loading and unloading is very convenient, accessible and user-friendly cleaning cartridge. The filter is sealed in the cylinder body, there are a number of vertical branch filter mounted on the filter, filter as a filter media, in sealed tube for pressure over the body.

### ■ 适用范围 Scope

制药工业：药业、生物制剂的过滤，各种溶剂过滤。

电子工业：高纯水系列的预过滤。

食品饮料工业：饮用水，饮料和酒的过滤。

化学工业：各种有机溶剂的过滤。

Pharmaceutical Industry: Pharmaceutical, biological filter, filter all kinds of solvents.

The electronics industry: high-water line of pre-filter.

Food and Beverage Industry: drinking water, wine and beverage filtration.

The chemical industry: a variety of organic solvents filter.

### ■ 主要性能 Key Features

滤芯直径：70mm

滤芯长度：20"或500mm

滤芯材质：PP滤纸、不锈钢滤网

Filter diameter: 70mm

Filter length: 20 "or 500mm

Filter material: PP filter paper, stainless steel filter



## XY-JL系列 滤芯式过滤机 XY-JL Series Filtering Core Filter

### 设备技术参数 Equipment technical parameters

### ■ 主要规格技术参数

#### The main specifications and technical parameters

型号 Model	筒体直径 Cylinder diameter Φ	过滤精度 Filtering accuracy ( μm )	工作压力 Working pressure ( Mpa )	工作温度 Working temperature ( ° C )	进出口径 Export Path ( mm )	外形尺寸 Dimensions ( mm )
XY-JL-3 × 20"	300	0.5、1、3、 5、10、15、 20、30、50、 100	0.4	90-150	DN40	Φ 500 × 1100
XY-JL-6 × 20"	350				DN40	Φ 700 × 1200
XY-JL-8 × 20"	400				DN50	Φ 800 × 1250
XY-JL-12 × 20"	500				DN50	Φ 1000 × 1300
XY-JL-20 × 20"	700				DN65	Φ 1200 × 1350
XY-JL-30 × 20"	800				DN80	Φ 1300 × 1380

### ■ 旭晔对材料的使用拥有多变的策略性

#### The use of material Xu Ye have strategic changing

主体材质：碳钢Q235B | 不锈钢SUS304 | 不锈钢SUS316L | 钛材TA2、TA3 | 哈氏合金 | 英科耐尔Inconel |

密封圈材质：丁晴橡胶 | 四氟 | 包四氟 | 氟橡胶

滤网材质：不锈钢SUS304 | 不锈钢SUS316L

The main material: Carbon steel Q235B | Stainless steel SUS304 Or SUS316L | Titanium TA2、TA3 | Inconel |

Ring material: NBR | tetrafluoroethylene | bag tetrafluoroethylene | Viton

Filter Material: Stainless steel SUS304 | stainless steel SUS316L







## XY-JL系列 滤芯式过滤机 XY-JL Series Filtering Core Filter

### ■ 钛棒过滤器

#### Titanium rod filter

钛棒过滤器使用的是钛粉末烧结滤芯，一般用于粗滤或中间过滤。此滤芯有精度高、耐高温、耐腐蚀、机械强度高优点，在医药行业广泛应用，外壳材料为316L或304不锈钢。

- 1、过滤精度：4 μm-50 μm
- 2、过滤效率：95%-99.99%
- 3、工作压力：≤0.4Mpa
- 4、工作温度：≤230° C
- 5、钛棒规格：Φ 60×300mm

Titanium rod filter using titanium powder sintered filter, generally used to filter or coarse filter in the middle. This filter has high accuracy, high temperature, corrosion resistance, high mechanical strength, widely used in the pharmaceutical industry, housing materials for the 304 or 316L stainless steel.

- 1、filtering accuracy: 4 μm-50 μm
- 2、filtration efficiency: 95% -99.99%
- 3、work pressure: ≤ 0.4Mpa
- 4、operating temperature: ≤ 230 °C
- 5、titanium rod specifications: Φ 60 × 300mm



### ■ 微孔过滤器

#### Millipore filter

微孔过滤器是一种膜分离技术，过滤器为圆柱体筒状结构，采用由进口滤膜制成滤芯，具有过滤精度高、面积大、速度快、无污染、不泄露等特点。是现代医药、电力、饮料、环保等工业的必备设备。

- 1、滤筒有1芯、3芯、5芯、7芯、9芯、11芯、13芯、15芯
- 2、折叠式滤芯长度有10"、20"、30"、40"
- 3、滤芯材质有聚四氟乙烯、尼龙、聚丙烯、醋酸纤维。
- 4、过滤孔径有0.1 μm、0.22 μm、0.45 μm、1 μm、3 μm、5 μm、10 μm、30 μm、60 μm，分疏水性（适用于气体）和新水性（适用于液体）滤芯，可根据需要选用。

Microporous filter is a membrane separation technology, a filter for the cylinder tube-like structure, by the use of imported membrane filter made with high-precision filter, with an area of large, fast and pollution-free, non-disclosure and so on. Of modern medicine, electricity, beverages, industry and environmental protection must-have device.

- 1, there is a cartridge-core, 3-core, Core 5, Core 7, 9 core, 11 core, the core 13, 15 core
- 2, folding length of the filter, 10 "and 20", 30 "and 40"
- 3, a PTFE filter material, nylon, polypropylene and cellulose acetate.
- 4, a filter pore size 0.1 μm, 0.22 μm, 0.45 μm, 1 μm, 3 μm, 5 μm, 10 μm, 30 μm, 60 μm, sub-hydrophobic (for gas) and water-based (for liquids) filter, can be selected.



## XY-N系列 A1、A2级压力容器及非标压力容器 XY-N Series A1, A2 Grade Pressure Vessel And Non-standard Pressure Vessels

### ■ 产品简介

#### Features of products

- 本公司除满足自身压力容器产品的设计与制造外，还对外大量承接压力容器及非标设备的设计与制造业务。包括：
- 1、储罐及分离设备系列：如各种容积的储罐及气压罐、机械过滤器、疏承扩容器、分汽缸、除氧器、离子交换器等。
  - 2、反应设备系列：包括电加热、半盘管加热、内盘管加热、夹套加热等各类反应釜及发酵罐。
  - 3、换热设备系列：包括各类换热器，如固定管板式、U型管式、浮头式、系列容积式、系列浮动盘管式等。
  - 4、塔设备系列：包括填料塔、筛板塔、浮阀塔、泡罩塔等。

The company in addition to meeting its own pressure vessel design and manufacture of products, but also to undertake a large number of foreign pressure vessels and non-standard equipment design and manufacturing business. It includes:

- 1, tanks and separation equipment Series: such as various volume of storage tanks and pressure tanks, mechanical filters, Cheng Shu expansion, a sub-cylinder, oxygen, ion exchange and so on.
- 2, reaction equipment series include: electric heating, half coil heating, inner coil heating jacket heating and other types of reactor and fermentor.
- 3, heat transfer equipment series: all kinds of heat exchangers, such as fixed tube plate, U-tube, floating head, volumetric series, series and other floating coil type.
- 4, Tower series: packed column, sieve tower. Float valve tower, bubble tower.







## XY-N系列 列管冷凝器、螺旋板式换热器 XY-N series Condenser Tube, Spiral Plate Heat Exchanger

### 产品简介 Features of products

我厂生产的列管冷凝器，按材质分为碳钢列管冷凝、不锈钢列管式冷凝器和碳钢与不锈钢混合列管式冷凝三种，按形式分为固定管板式、浮头式、U型管式换热器，按结构分为单管程、双管程和多管程。传热面积0.5-500m<sup>2</sup>，可根据用户需要定制。



I plant condenser tube, carbon steel tube material into condensation, stainless steel and carbon steel tube condenser with stainless steel mixing tube condensing three kinds, according to the form is divided into fixed tube sheet, floating head, U-tube heat exchanger, according to the structure into a single tube, double tube and multiple tube. Heat transfer area 0.5-500m<sup>2</sup>, can be customized according to user needs.

### 主要技术参数 The main technical parameters

公称直径 Nominal diameter	管程数 Tube Number	管子数量 Number of tubes	换热面积公称值/计算值 Heat transfer area Nominal value / calc					管程通道截面积，管程通道流速为0.5m/sec时的流量m/hr		公称压力 Nominal pressure
			管子长度 Pipe length ( m )					碳钢管 Carbon steel pipe Φ25x2.5	不锈钢管 Stainless Steel Pipe Φ25x2	
			5000	2000	3000	4000	6000			
159	I	14	1.5/1.62	2/2.17	3/3.27			0.0044/0.0049	7.92/8.82	0.25
219	I	26	3/3.00	4/4.02	6/6.06	8/8.11		0.0082/0.0090	14.76/16.20	0.6
	II	26	3/3.00	4/4.02	6/6.06	8/8.11		0.0041/0.0045	7.38/8.10	1.0
273	I	44	5/5.08	7/6.18	10/10.26	14/13.72	21/20.63	0.0138/0.0152	24.84/27.36	1.6
	II	40	5/4.62	6/6.19	9/9.33	12/12.47	19/18.76	0.0063/0.0069	11.34/12.42	2.5
325	I	60	7/6.93	9/9.28	14/14.00	19/18.71	28/28.13	0.0188/0.0208	33.84/37.44	0.6
	II	56	6/6.47	9/8.66	13/13.06	17/17.46	26/26.26	0.0088/0.0097	15.84/17.46	1.0
400	I	119	14/13.74	18/18.41	28/27.76	37/37.10	55/55.8	0.0374/0.0412	67.32/74.16	1.6
	II	110	13/12.70	17/17.02	26/25.66	34/34.20	50/51.58	0.0173/0.0190	31.14/34.20	2.5
500	I	185			45/4.15	55/57.68	85/86.74	0.0581/0.0641	104.58/115.38	
	II	180			40/41.99	55/57.68	85/86.74	0.0283/0.0312	50.94/56.16	
600	I	169			60/62.7	85/83.88	125/126.13	0.0845/0.0932	152.10/167.76	
	II	266			60/62.05	80/82.94	125/14.72	0.0418/0.0461	75.24/82.98	
700	I	379			90/88.41	120/118.17	175/177.71	0.0091/0.1313	214.38/236.34	
	II	358			85/83.51	110/111.62	165/167.86	0.0562/0.0620	101.16/111.60	
800	I	511			120/119.20	160/159.16	240/239.60	0.1605/0.1770	288.90/318.60	
	II	488			115/113.83	150/152.16	230/228.81	0.0767/0.0845	138.06/152.10	
900	I	649			150/151.39	200/202.36	305/304.3	0.2039/0.2248	367.02/404.46	
	II	630			145/146.96	195/196.44	295/295.40	0.0990/0.1091	178.20/196.38	
1000	I	805			185/187.78	250/251.00	375/377.45	0.2529/0.2788	455.22/501.84	
	II	792			185/184.75	245/246.95	370/371.36	0.1244/0.1374	233.92/246.96	



## XY-DH系列 碟片离心机 XY-DH Series Disc Centrifuge

在很多领域中，分离是必不可少的重要环节，旭晔碟片离心机可满足您个性化的分离工艺，并使加工效率最大化。碟片离心机专业用于二相分离和三相分离，二相分离是从液体中分离固体悬浮物或者把两种不同比重互不相溶的液体分离；三相分离则分别将二相不互溶的液体和一相固体同时分离。

In many areas, the separation is the essential part, Xu Ye disc centrifuge can meet your personalized separation process and maximize processing efficiency. Liquid phase separator were biphasic immiscible; professional disc centrifuge for two-phase separation and three phase separator, two phase separation is the separation of suspended solids from the liquid or the proportion of two different mutually insoluble liquid separation and a simultaneous separation of the solid phase.

### 产品特点 Features

具有转速高、运转平稳、进出口系统全部密封、噪音小、分离效果好等优点。自行专业设计的向心泵系统具有输出压力稳定，调节范围大。操作方便等特点。自控系统核心采用西门子S7-200 S7-300等核心控制元件，有效监控设备自身安全运转，预留DCS接口，方便车间集中控制设备。

With a high speed, stable operation, import and export systems are all sealed, low noise, good separation and so on. Have their own professionally designed centripetal pump system output pressure stability, large adjustment range. Operate and convenient. Siemens Automation System S7-200 S7-300 core core control elements, effectively monitor the safe operation of the device itself, reserve DCS interface to facilitate centralized control equipment workshop.



### 工作原理 Working principle

被分离的物料输入该机的心脏部分即转鼓内部，在强大的离心力的作用下，物料（混合液）经过一组碟片束的间隔中，以碟片中性孔为分界面，比重较大的液体（重相）沿碟片壁向中性孔外运动，其中重渣积聚在沉渣区，重相则流向大向心泵处。比重较小的液体（轻相）沿碟片壁向内向上运动，汇聚至小向心泵处。轻重相分别由小向心泵和大向心泵输出。

The separated materials enter the heart of the machine that is inside the drum, in a strong centrifugal force, the material (mixture) through a set of spaced discs beam, neutral hole in the disc interface, the proportion of the more large liquid (heavy phase) to neutral hole along the outside wall of the disc movement, which accumulate in the sediment zone heavy residue, heavy with the flow to the heart pump at large. A smaller proportion of liquid (light phase) inward upward movement along the disc wall, to a small gathering at the heart pumps. Respectively, by weight relative to the small and large pump output to the heart to the heart pumps.

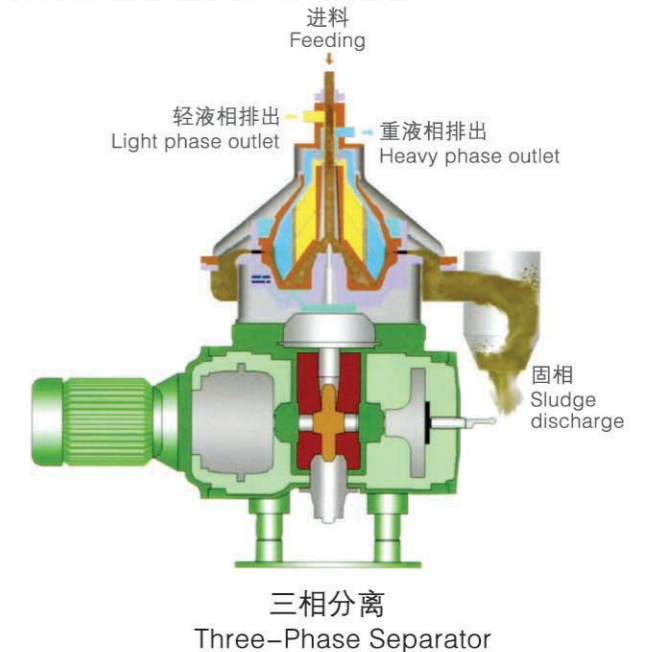
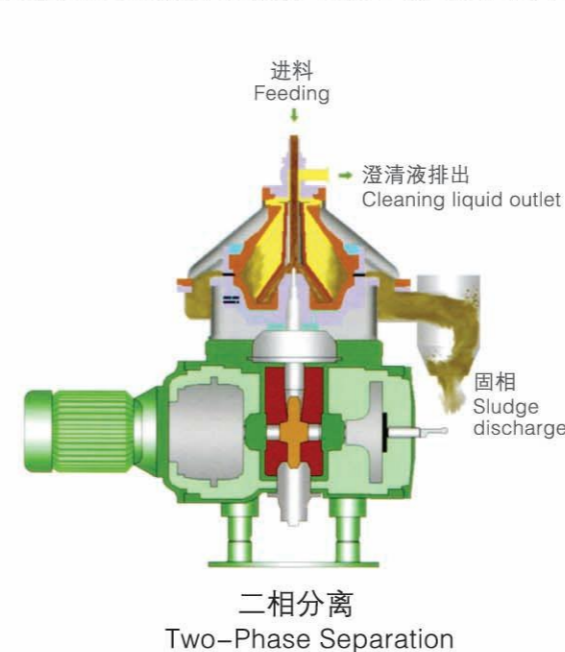





## XY-DH系列 碟片离心机 XY-DH Series Disc Centrifuge

设备技术参数  
Equipment technical parameters

### 主要规格技术参数

#### The main specifications and technical parameters

型号 Model	处理量 Treatment Capacity(L/H)	进口压力 Inlet Pressure ( Mpa )	出口压力 Outlet Pressure ( Mpa )	电机功率 Motor Power ( Kw )	重量 Weight ( Kg )	外形尺寸 Dimensions ( mm )
DHZ360	1200~2500	0.05	0.1~0.25	7.5	1280	1500 × 1150 × 1500
DHZ470	2500~7000	0.05	0.1~0.25	15	1880	1800 × 1200 × 1800
DHZ550A	5000~10000	0.05	0.1~0.25	18.5	2200	1850 × 1550 × 2050
DHZ550E	6000~15000	0.05	0.1~0.25	22	2200	1850 × 1550 × 2050
DHZ700	15000~30000	0.1	0.2	30	3300	2100 × 1650 × 2300
DRZ360	1200~2500	0.05	0.1~0.25	5.5	750	1250 × 1050 × 1500
DRZ400A	2000~6000	0.05	0.1~0.3	7.5	1150	1300 × 900 × 1450
DRZ400E	4000~7500	0.05	0.1~0.3	7.5	1300	1300 × 900 × 1500
DRZ550	6000~18000	0.05	0.1~0.3	22	2200	1620 × 1300 × 2200

### 旭晔对材料的使用拥有多变的策略性

#### The use of material Xu Ye have strategic changing

主体材质: 碳钢Q235B | 不锈钢SUS304 | 不锈钢SUS316L | 钛材TA2、TA3 | 哈氏合金 | 英科耐尔Inconel |

密封圈材质: 丁晴橡胶 | 四氟 | 包四氟 | 氟橡胶

滤网材质: 不锈钢SUS304 | 不锈钢SUS316L

The main material: Carbon steel Q235B | Stainless steel SUS304 Or SUS316L | Titanium TA2、TA3 | Inconel |

Ring material: NBR | tetrafluoroethylene | bag tetrafluoroethylene | Viton

Filter Material: Stainless steel SUS304 | stainless steel SUS316L

### 适用范围

#### Scope

动、植物油脂精炼 医药中间体固液分离, 化工中间体固液分离, 中药制剂固液分离等。

Animal or vegetable oil refining liquid separation pharmaceutical intermediates, chemical intermediates solid-liquid separation, solid-liquid separation and other traditional Chinese medicines.



## XY-DH系列 卧式螺旋卸料沉降离心机 XY-DH Series Horizontal Screw Centrifuge

### 适用范围

#### Scope

卧式螺旋卸料沉降离心机适用于固相粒度0.005~15mm、浓度1—40%、温度≤100℃的各类悬浮液的固相脱水、液相澄清分离和液、液、固三相分离及颗粒分级等。尤其适用于滤布再生有困难及浓度、颗粒变化较大的悬浮液分离。如聚氯乙烯树脂、亚硫酸铵、碳酸钡、硫酸锶、立德粉、淀粉、硅藻土、石膏、铝土矿、大豆蛋白、花生蛋白、果汁、饮料、植物油、柠檬酸、血粉、钛白粉、高岭土 钻井泥浆等加工和精煤脱水、粉煤脱水、废油净酒糟废液、矿物分级处理、市政污水处理以及电厂污泥 印染污泥、造纸污泥等工业废水处理领域。

Horizontal Screw Centrifuge suitable for solid-phase particle size 0.005 ~ 15mm, the concentration of 1-40% solids suspension of all kinds of temperature ≤ 100 °C phase dehydration, liquid separation and fluid clarification, liquid and solid separation and particle grading. Especially for cloth regeneration difficult and concentration, changes in the larger particles separated suspension. Such as polyvinyl chloride resin, ammonium sulfite, barium carbonate, strontium sulfate, lithopone, starch, diatomaceous earth, gypsum, bauxite, soy protein, peanut protein, juice, beverage, vegetable oil, citric acid, blood meal, titanium white powder, kaolin drilling mud and other processing and coal dewatering fine coal dewatering, waste oil net lees, mineral grading treatment, municipal wastewater treatment plant sludge and sludge printing and dyeing, paper and other industrial wastewater treatment sludge.

### 性能特点

#### Features

卧式螺旋卸料沉降离心机能在全速运转下连续进料、分离和卸料。具有结构紧凑、易于密闭、运行平稳 噪声小、处理量大、能耗低自动化程度高、劳动强度小、操作维护方便、适应范围广等特点。

Horizontal Screw Centrifuge continuous feed at full speed, separation and discharge. With a compact, easy-to-sealed, smooth running and low noise, high processing capacity, low energy consumption degree of automation, low labor intensity, easy to operate and maintain, adapt to a wide range of features.



转鼓  
Drum



卸料螺旋  
Discharge screw





## XY-DH系列 卧式螺旋卸料沉降离心机 XY-DH Series Horizontal Screw Centrifuge

### ■ 结构原理 Structural principle

无孔转鼓内套装有目的卸料螺旋，两者高速同向旋转的同时，又具有一定的转速差，该转速差由传动系统及差速器产生。悬浮液由进料管进入输料螺旋内腔。经加速后进入转鼓内。在离心力作用下，密度较大的固相颗粒物沉降到转鼓内壁。形成沉渣环层，并被卸料螺旋不断推送到转鼓小端而排出转鼓外，澄清的液体不断从转鼓大端的溢流口排出转鼓外，从而实现悬浮液的固液分离。

Within nonporous drum kit there for heart discharge screw, both co-rotating at the same speed, but also has some speed difference, the speed difference is generated by the transmission and differential. Suspension from the feed tube into the feeding scroll lumen. After accelerating into the drum inside. Under the centrifugal force, the denser solid particles were allowed to settle to the drum wall. The outer ring layer of sediment is formed, and is constantly pushed to the discharge screw and the drum small end discharge drum, a clear liquid continuously from the large end of the drum overflow port is discharged outside the drum, in order to achieve solid-liquid separation of the suspension.

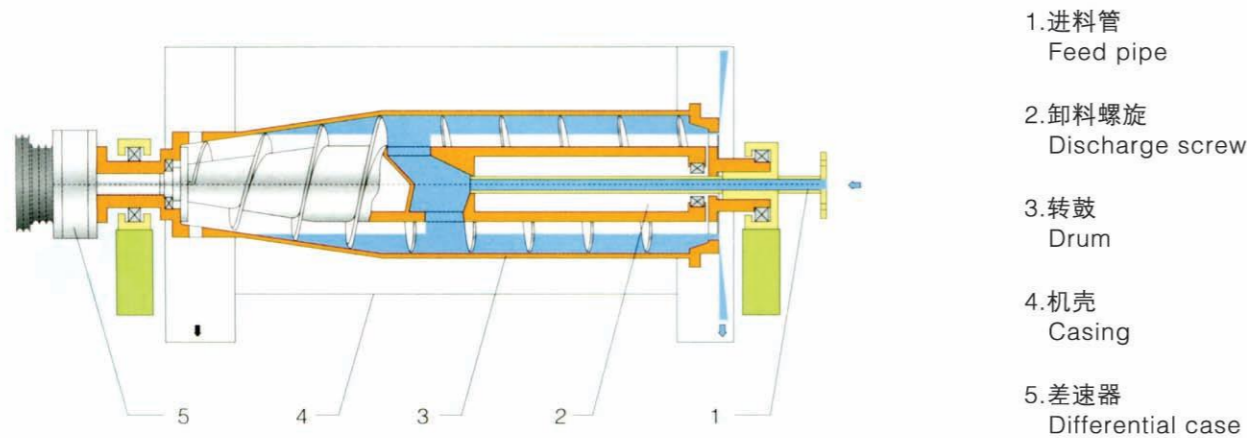

齿轮差速器  
Satellite

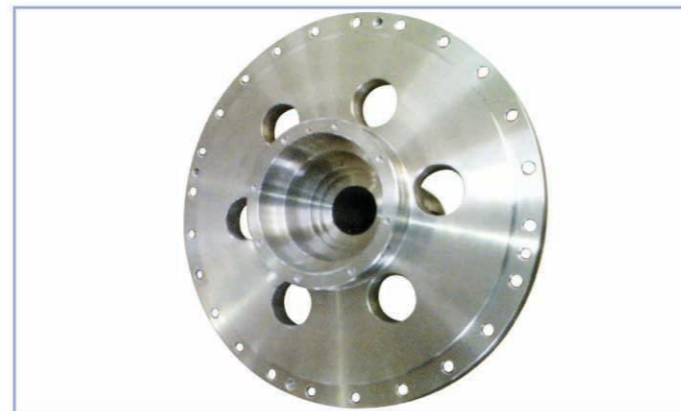

端盖  
Drum cover



## XY-DH系列 卧式螺旋卸料沉降离心机 XY-DH Series Horizontal Screw Centrifuge

### 设备技术参数 Equipment technical parameters

### ■ 主要规格技术参数 The main specifications and technical parameters

型号规格 Model Specifications	转鼓直径 Drum's nominal diameter (mm)	转鼓长度 Drum length (mm)	最高转速 Drum speed (rpm)	最大分离 因素 Separating factor	处理能力 Capacity (m <sup>3</sup> /h)	主电机 功率 Power of main motor (Kw)	重量 Weight (Kg)	外形尺寸 Dimensions 长×宽×高 length×width×height (mm)
LW250×1000—N	250	1000	5400	4080	0.5~5	7.5	1000	2410×800×1080
LW300×1200—N	300	1200	4200	3000	1~5	7.5~11	1200	2610×800×1080
LW400×1200—N (三相)	400	1200	3650	3000	1~5	15~18.5	2500	2990×960×1205
LW400×1600—N	400	1600	3650	3000	2~20	15~22	2500	3690×1020×1205
LW400×1800—N	400	1800	3650	3000	2~25	15~22	2500	3890×1020×1205
LW400×1800—N (三相)	400	1800	3650	3000	2~25	15~22	2500	3890×1020×1205
LW450×2000—N	450	2000	3450	3000	3~35	22~37	3000	4297×1080×1385
LW450×2000—N (三相)	450	2000	3450	3000	3~35	22~37	3000	4297×1080×1385
LW450×2150—N	450	2150	3450	3000	4~40	22~37	3200	4447×1080×1385
LW500×2000—N (三相)	500	2000	3000	2500	5~45	30~37	3800	4330×1140×1470
LW500×2250—N	500	2250	3000	2500	8~50	37~45	4000	4580×1140×1470
LW530×2280—N	530	2280	2900	2500	15~65	45~55	5000	4924×1170×1540
LW530×2280—N (三相)	530	2280	2900	2500	15~65	45~55	5000	4924×1170×1540
LW580×2500—N	580	2500	2780	2500	20~80	55~75	6500	5205×1270×1540

### ■ 旭晔对材料的使用拥有多变的策略性 The use of material Xu Ye have strategic changing

主体材质: 碳钢Q235B | 不锈钢SUS304 | 不锈钢SUS316L | 钛材TA2、TA3 | 哈氏合金 | 英科耐尔Inconel |

密封圈材质: 丁晴橡胶 | 四氟 | 包四氟 | 氟橡胶

滤网材质: 不锈钢SUS304 | 不锈钢SUS316L

The main material: Carbon steel Q235B | Stainless steel SUS304 Or SUS316L | Titanium TA2、TA3 | Inconel |

Ring material: NBR | tetrafluoroethylene | bag tetrafluoroethylene | Viton

Filter Material: Stainless steel SUS304 | stainless steel SUS316L



## XY-G系列 管道过滤器 XY-G Series Pipeline Filter



XY-G型篮式过滤器主要有：过滤缸筒体、过滤缸盖、不锈钢烧结滤篮等主要部件组成。该种过滤器是一种压力过滤装置，液体由过滤器外壳的旁侧入口管流入滤篮，滤篮本身强度较大，液体渗透过所需要细度等级的滤篮即能获得合格的滤液，杂质颗粒被滤篮捕捉。该机更换滤篮十分方便，过滤基本无物料消耗。滤篮不必更新，可反复长期使用。

XY-G-filter basket are: filter tank shell, the filter head, stainless steel sintered filter Blue and other major components.

The filter is a kind of pressure filter, filter the liquid from the shell side entrance into the pipe filter basket, the filter basket is greater intensity, liquid infiltration had required fineness grade filter basket that can be qualified filtrate, Impurity particles were captured filter basket. The aircraft replacement filter basket is very convenient, without the basic filter material consumption. Do not have to update the filter basket can be repeated a long-term use.

### 产品特点 Features

- 1、过滤器配有一个简单的开启压盖，更换过滤篮时快速方便。
- 2、进口烧结网滤篮细度规格为0.3 μm以上，用户可按照自己的质量要求挑选。
- 3、滤出的固体留在过滤篮内，可采用实用、安全的方法处理。
- 4、通过流速快，持续时间长，操作成本低，清洗十分方便。
- 5、不需助滤剂，滤篮可清洗后反复使用，密闭操作无污染。

- 1、 filter container with a simple turn of the gland, the replacement of filter basket Fast when convenient.
- 2、 net imports of sintered filter basket size specifications for more than 0.3 μm, in accordance with the user can select their own quality requirements.
- 3、 filter out the solids remain in the filter basket, can be practical and safe manner.
- 4、 flow rate through the fast, long duration, low-cost operation, easy cleaning.
- 5、 with no filter aid, the filter basket can be cleaned after repeated use, pollution-free operation closed.

### 适用范围 Scope

XY-G型快捷篮式管道过滤器广泛适用于化工、涂料、染料、油品、制药、食品酿造、饮料、医药、环保等行业≤1Pa.s粘度液体的精细过滤。

XY-G-fast channel-filter basket widely applicable to chemical, coatings, dyes, oil, pharmaceutical, food production, beverages, medicine and environmental protection industries ≤ 1Pa.s viscosity of the liquid filtration fine.

### 技术参数 Technical parameters

进出口径 (mm)	滤芯目数
DN25 DN30	4目-110目
DN45 DN50	
DN60 DN80	
DN100 DN125	
DN150 DN200	
DN300 DN400	
DN500 DN600	



空气过滤器 Air filter  
管道过滤器 Pipeline filter  
Y型卫生级管道过滤器 Sanitation pipeline filter model Y  
卫生级呼吸器 Sanitation rebreather

## 泵阀系列 Valve Series



将原料制成半成品和成品，需要经过复杂的工艺过程，泵在这些过程中起到了输送液体和提供化学反应的压力流量的作用。

The raw material of semi-finished and finished products, need to go through a complex process, the pump plays a role in the transmission fluid and provide chemical reaction of pressure and flow in these processes.



IH型化工离心泵  
IH chemical centrifugal pump

介质温度 Medium temperature: -20~105° C  
流量 Flow: 1.6-400m³/h  
扬程 Head: 5-125m

IH泵为单级单吸悬臂式离心泵，是取代F型耐腐蚀离心泵的节能、换代产品。能满足化工流程中输送腐蚀性粘度类似水的液体。IH pump is single stage single suction cantilever centrifugal pump, to replace the F-type corrosion-resistant centrifugal pump



FSB-L型离心泵  
FSB-L type centrifugal pump

流量: 1.5-200m³/h  
扬程: 10-80m  
材质: 氟塑料合金、聚偏二氟乙烯、增强聚丙烯  
Flow: 1.5-200m³/h  
Head: 10-80m  
Material: fluorine plastic alloy, polyvinylidene fluoride, reinforced polypropylene



FZB□-□-□型自吸泵  
FZB □ - □ - □ type self-priming pump

流量: 1.5-50m³/h  
扬程: 15-30m  
材质: 氟塑料合金、增强聚丙烯  
Flow: 1.5-50m³/h  
Head: 15-30m  
Material: fluorine plastic alloy, reinforced polypropylene



IHF型衬塑型  
IHF type lined type

流量: 1.5-400m³/h  
扬程: 20-80m  
材质: 氟塑料合金、聚偏二氟  
Flow: 1.5-400m³/h  
Head: 20-80m  
Material: fluorine plastic alloy, polyvinylidene fluoride





耐蚀合金材料选用表  
Corrosion Resistant Alloy Material Selection

序号	牌号	代号	适用介质
1	F30%CrMo	Cr30	是含固量达35%腐蚀性介质的理想用材, 如磷酸萃取料浆等类似腐蚀磨蚀性介质, 目前居国内领先水平
2	1Cr18Ni9Ti	18-8	碱液、醋酸、稀硝酸
3	00Cr20Ni25Mo4	UB6	含一定数量的Cl、F、SO磷酸、硫酸及高温醋酸, 抗点蚀和晶间腐蚀。
4	00Cr14Ni4Si4	C4	全浓度硝酸、特别适用浓硝酸, 是目前浓硝酸用钢综合性最好的铸材。
5	0Cr12Ni25Mo3Cu3Si2Nb	941	全浓度常温硫酸, 特别适用100° C以下的中等浓度(50%左右)硫酸。
6	00Cr10Ni20Mo1.5Si6Cu	SS920	高温浓硫酸, t≤130° C, 浓度93-98%
7	0Cr21Ni32Mo2Cu3	20#合金	高温浓硫酸, t≤130° C, 浓度40%
8	Z180C13	DF2	含固量达70%磨蚀性介质。
9	0Cr26Ni5Mo2Cu3	CD-4Mcu	含固稀硫酸, 磷酸, 耐磨, 耐蚀。
10	0Cr25Ni6Mo2Cu2	K合金	≤60° C各种浓度的硫酸。
11	00Cr25Ni6Mo2	MM-4	硝酸磷肥专用钢
12	0Cr18Ni9	304	稀硝酸, 有机酸。
13	00Cr18Ni9	304L	稀硝酸, 有机酸, 抗晶间腐蚀
14	0Cr18Ni12Mo2Ti	Mo2Ti	稀硝酸, 硫酸, 有机酸
15	0Cr18Ni12Mo2	316	稀硝酸, 硫酸, 有机酸
16	00Cr18Ni12Mo2	316L	稀硝酸, 硫酸, 有机酸, 抗晶间腐蚀
17	0Cr20Ni25Mo5Cu2	904	70° C以下各种浓度硫酸, 抗晶间腐蚀
18	0Cr30Ni42Mo3Cu2	804	烧碱蒸发及904仍不抗蚀等。
19	0Cr20Ni42Mo3Cu2	824	904仍不抗蚀介质
20	0Cr18Ni5Mo5	NH55	海水
21	0Cr20Ni33Mo3Cu2	20Cb3	各种浓度的硫酸腐蚀
22	0Cr24Ni33Mo2.5Cu3Ti	3#4#	含20%固相的稀硫酸磨损腐蚀
23	0Cr16Ni4Cu3Nb	CB-7Cu	砂浆磨蚀、钾肥生产时卤水的磨、腐蚀
24	00Cr30Ni40Mo4Cu3	Lewmet55	125° C高温发烟硫酸腐蚀
25	00Ni65Cu28	Monel	氢氟酸、硅氟酸、高温烧碱
26	00Ni65Mo28	哈氏B	全浓度盐酸
27	塑料FEP	F46	各种酸、碱、盐、氯化剂等介质。
28	UHMWPE		80° C以下含悬浮固体颗粒的酸、碱、盐介质。



氟塑料F46的耐腐蚀性能 聚偏氟乙稀 (PVDF) 耐腐蚀性能  
F46 Fluorine Plastic Corrosion Resistance  
PVDF (PVDF) Corrosion Resistance

化学介质	使用温度。C	化学介质	使用温度。C
醋酸	沸点	二乙基醚	沸点
盐酸	沸点	己二酸二异丁脂	沸点
氢氟酸	沸点	偏二甲胍	沸点
过氧化氢	66	对氧六环	沸点
硝酸	沸点	醋酸酯	沸点
氢氧化钾	沸点	氟茶	沸点
高锰酸钾	沸点	氟化硝基苯	沸点
氢氧化钠	沸点	呋喃	沸点
硫酸	沸点	六氯乙烷	沸点
丙酮	200	联氨	沸点
苯乙酮	沸点	甲乙酮	沸点
苯氨	沸点	苯酚	沸点
苯甲酰氯	沸点	硝基苯	沸点
苜醇	沸点	四氧化二氮	沸点
甲酚	沸点	全氟二甲苯	沸点
环乙酮	沸点	酚	沸点
癸二酸二丁酯	沸点	全氯乙烯	沸点
芳香族脂肪族溶剂	200	磷酸	沸点
吡啶	沸点	氯酸碳	94
蒽烯	沸点	环乙烷	150
肥皂洗涤剂	沸点	邻苯二甲酸二丁脂	200
次亚氯酸钠	沸点	二甲基甲酰胺	150
过氧化钠	沸点	乙醇	200
四溴乙烷	沸点	溴乙烯	100
三氯乙酸	沸点	乙烯基乙二醇	150
三氯乙烯	沸点	蚁酸	100
松香酸	182	火油	94
无水醋酸	150	动植物油	200
液氨	26	臭氧	26
溴	94	五氯化磷	94
正丁胺	150	哌啶	105
醋酸丁脂	127	氯仿	63
二硫化碳	46	二氯化锡	200
十六烷	52	二甲苯	139
氯	94	亚磷酸三甲苯脂	150

化学介质	浓度	最高使用温度。C	化学介质	浓度 %	使用温度。C
盐酸	36	135	氢氧化钠		85
硫酸	<60	120	氢氧化钠		50
硫酸	80-93	95	碳化铵		110
硫酸	90	65	碳化钙		135
硝酸	<50	50	碳酸钠	水溶液	135
硝酸	<85	135	碳酸氢钠	水溶液	120
磷酸	85	110	氨水		110
磷酸	10	110	盐水		135
醋酸	80	80	磷酸氢钠	水溶液	120
醋酸	100	50	磷酸钙	水溶液	135
醋酸	<10	95	氯化钙	水溶液	135
三氯醋酸	50	50	氯化钾	水溶液	135
三氯醋酸		50	氯化铵	水溶液	135
草酸	水溶液	50	三氯化铁	水溶液	135
苯磺酸	40-100	95	硫酸亚铁	水溶液	135
氢氟酸	40	120	硝酸铵	水溶液	135
氢氟酸	50	135	硝酸钠	水溶液	135
氢溴酸	10	95	磷酸铵	水溶液	135
过氯酸	70	50	尿素	水溶液	120
次氯酸钠	6-15	95	二氧化氮		80
氯酸钾		100	二氧化氮		75
铬酸	<40	80	二氧化氮		65
铬酸	50	50	氯	元素	95
高锰酸钾		120	溴	元素	65
过氧化氢	<30	95	碘	元素	65
过氧化钠		95	三氯甲烷		50
乙醇		135	四氯化碳		135
乙醚		50	氯乙烷		135
甲醛	37	50	1,2-三氯乙烷		135
丙酮	10%水	50	1,1,2-三氯乙烷		65
胍	溶液	95	四氯乙烷		120
苯	水溶液	75	氯乙烯		95
苯胺		50	三氯乙烷		135
甲苯		85	二氯乙烯		110
苯酚		50	天然气		135
氯苯		135	燃料油		135
萘		95	石蜡油		120
氯甲烷		135			





设备发货现场  
Equipment Delivery Site



设备使用现场  
Equipment Use Site

